

Additif



**P.R. 880
CATALOGUE
DE PIÈCES
DE RECHANGE**

R 1180

RENAULT



14. Juli 1969

régie nationale des usines Renault

Planches à rayer dans le catalogue P.R.880 :
Nachstehende Bildtafeln des P.R.880 durchstreichen :
Pagine da annullare nel catalogo P.R.880 :

00.01 A - 01.02 A - 01.03 A - 01.04 A - 01.10 A
14.20 A - 14.50 A - 15.01 A - 15.80 A - 17.20 A
18.80 A - 30.01 A - 40.10 A - 43.40 A - 44.01 A
51.40 A - 51.50 A - 58.25 A - 58.55 A - 58.70 A
61.05 A - 61.35 A - 81.40 A - 81.70 A - 82.10 A
82.20 A - 82.50 A - 82.55 A - 82.58 A - 82.90 A
84.31 A - 84.36 A - 84.40 A - 84.50 A - 84.55 A
84.60 A - 85.50 A - 85.90 A

Der Franzose

P.R. 880

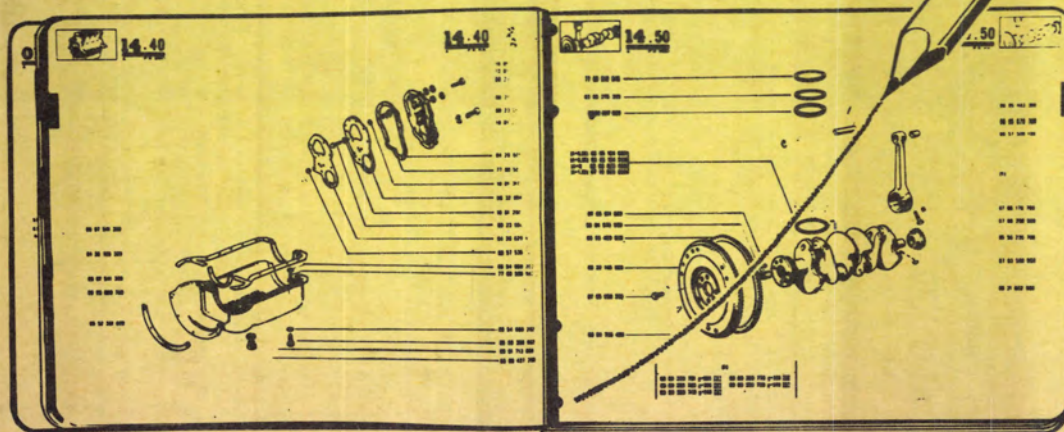

Additif

**P.R. 880
CATALOGUE
DE PIÈCES
DE RECHANGE**

R1180

RENAULT
régie nationale des usines Renault



R 1180

01.10
B P.R. 880

régie nationale des usines Renault

8 et 10 avenue Emile-Zola

Boîte Postale 103 - 92 Boulogne-Billancourt, France

tél. Paris (1) - 603-13-13 - registre du commerce Seine

55 b 8620 - adresse télégraphique Renofer Paris

telex Paris 20094 - no d'entreprise 261 75 012 9001

1	2	3	4	5	6	1969
7	8	9	10	11	12	

FRANÇAIS

**Catalogue de
pièces de rechange**

P.R. 880

1^o ÉDITION

Additif

Reproduction ou traduction, même partielle,
interdite sans l'autorisation écrite de la Régie
Nationale des Usines Renault.

DEUTSCH

Ersatzteilkatalog

P.R. 880

1. AUSGABE

Nachtrag

Nachdruck oder Übersetzung, selbst auszugs-
weise, sind nicht gestattet ohne besondere
schriftliche Genehmigung der Régie Nationale
des Usines Renault.

ITALIANO

**Catalogo dei pezzi
di ricambio**

P.R. 880

1a EDIZIONE

Aggiunta

Riproduzione of traduzione, anche parziali,
vietate senza autorizzazione scritta della Régie
Nationale des Usines Renault.

P.R. 880
R 1180

01.10 B

R 0000
000
0000000

02.01... A

UTILISATION
GEBRAUCHSANWEISUNG
USO DEL CATALOGO

03.01...



05.01... A

R.0000 /00/00/00

05.40... A

14



14.01 A

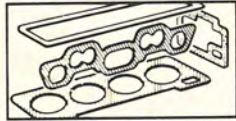

14.10 A

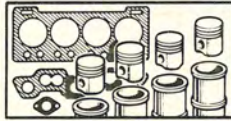

14.15 A

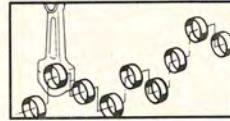

14.20 B

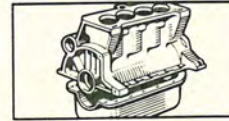

14.30 A—14.40 A

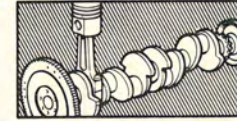

14.50 B

14

15

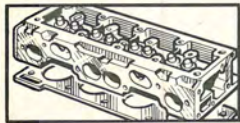

15.01 B

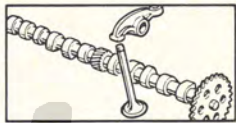

15.20 A

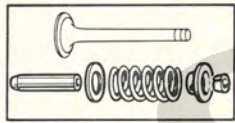

15.30 A

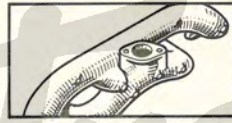

15.35 A



15.40 A—15.41 A



15.50 A



15.55 A

15

15
16
17

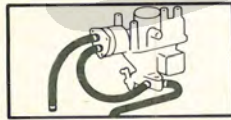

15.75 A

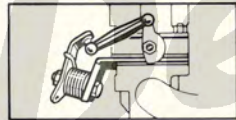

15.80 B



15.85 A — 15.87 A



16.01 A

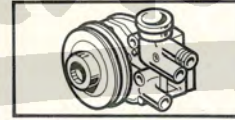

17.01 A



17.20 B

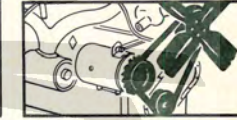

17.50 A

15
16
17

18

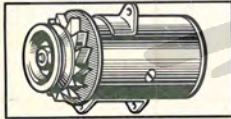

18.01 A—18.05 A

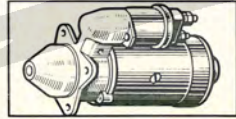

18.20 A

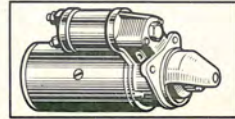

18.30 A

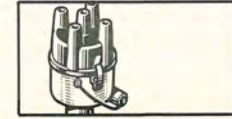

18.40 A—18.50 A

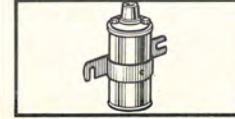

18.60 A

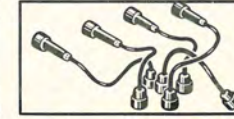

18.70 A

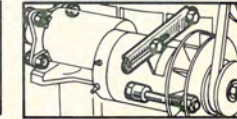

18.80 B

18

19
30
31



19.01 A—19.05 A
19.10 A

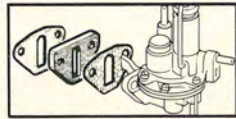

19.20 A

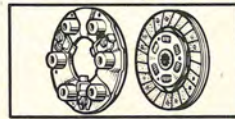

30.01 B



31.01 A—31.20 A

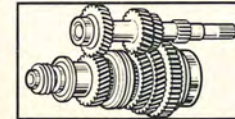

31.30 A

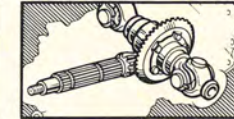

31.40 A



31.50 A

19
30
31

35
40
42

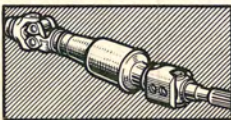

35.05 A

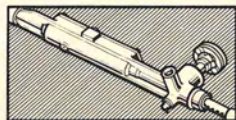

40.01 A

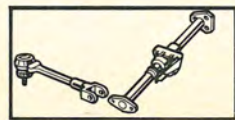

40.10 B

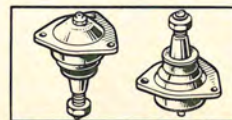

42.05 A



42.10 A

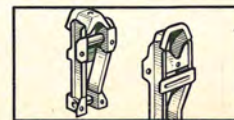

42.20 A

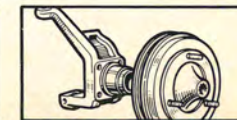

42.30 A

35
40
42

42
43

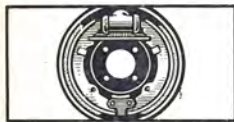

42.40 A

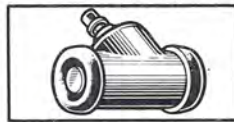

42.50 A

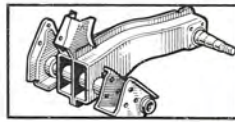

43.01 A

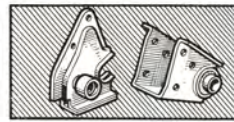

43.10 A



43.20 A

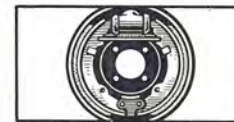

43.40 B

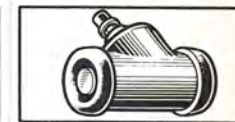

43.50 A

42
43

44
50



44.01 B

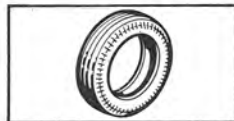

44.10 A

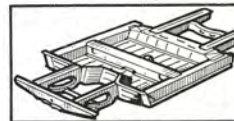

50.01 A



50.05 A-50.10 A

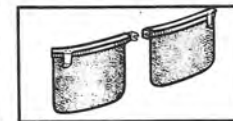

50.15 A

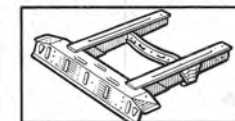

50.20 A

44
50

51
58

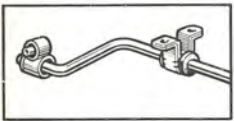

51.01 A-51.05 A

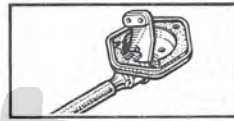

51.10 A

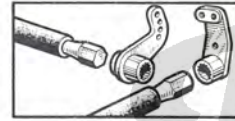

51.15 A

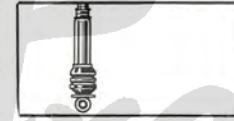

51.40 B-51.50 B

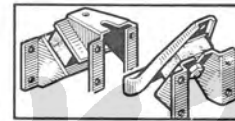

51.60 A



58.01 A-58.05 A

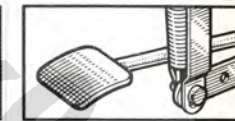

58.10 A-58.15 A

51
58

58

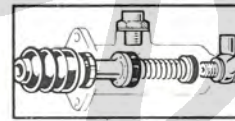

58.25 B



58.30 A

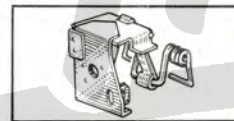

58.40 A

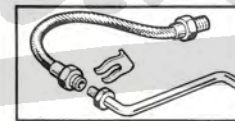

58.45 A-58.50 A

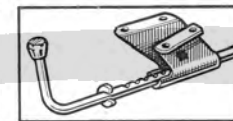

58.55 B-58.60 A



58.70 B

58

60

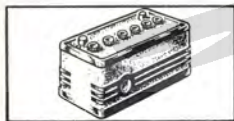

60.01 A

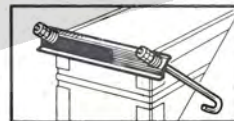

60.05 A



60.10 A-60.15 A

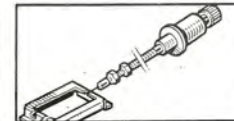

60.18 A

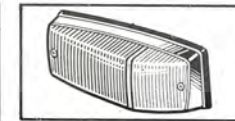

60.30 A



60.40 A



60.50 A

60

60



60.55 A



60.60 A



60.65 A

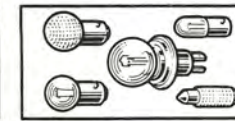

60.70 A

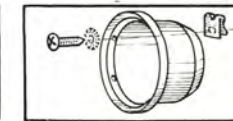

60.75 A

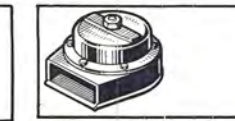

60.80 A

60

61



61.01A-61.02 A

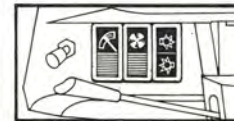

61.05 B

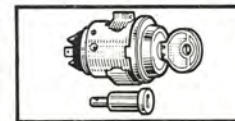

61.10 A



61.15 A

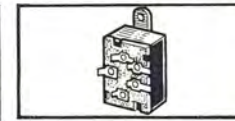

61.20 A

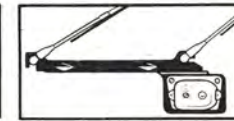

61.25 A-61.35 B

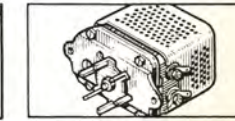

61.27A-61.37 A

61

61
62



61.45 A

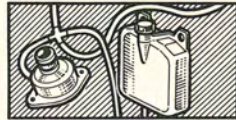

61.47 A



61.50 A



61.55 A

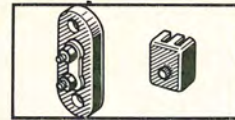

62.01 A



62.10 A

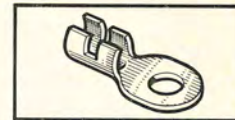

62.20 A

61
62

62
70
71

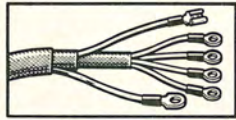

62-70 A

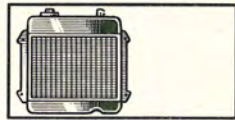

70.01 A



70.10 A



71.01 A

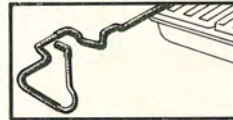

71.20 A

62
70
71

73
78
81

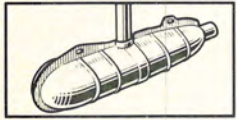

73.01 A

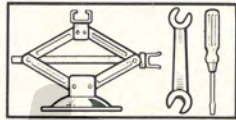

78.01 A



81.01 A



81.10 A

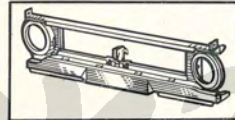

81.15 A



81.20 A



81.30 A

73
78
81

81



81.40 B



81.50 A



81.60 A



81.70 B

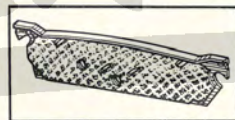

81.80 A

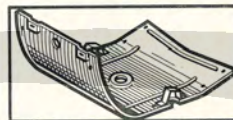

81.85 A

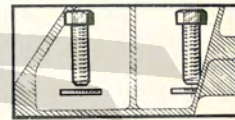

81.90 A

81

82



82.01 A



82.05 A

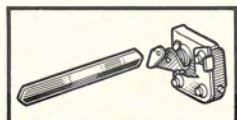

82.10 B — 82.20 B

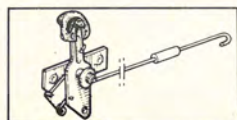

82.30 A — 82.35 A

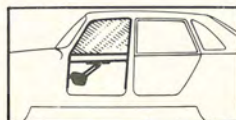

82.50 B

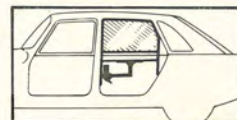

82.55 B

82



82.58 B



82.60 A

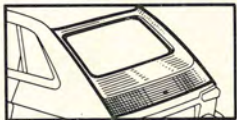

82.70 A

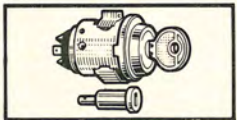

82.75 A

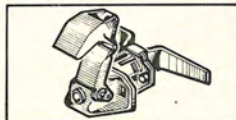

82.85 A



82.90 B

84



84.00 A



84.05 A



84.11 A — 84.15 A

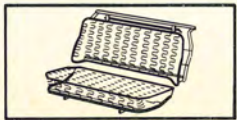

84.20 A



84.26 A



84.31 B — 84.36 B

84

84

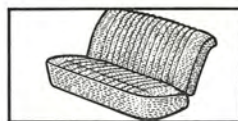

84.40 B — 84.50 B

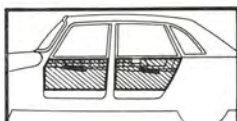

84.55 B

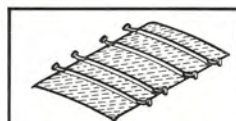

84.60 B

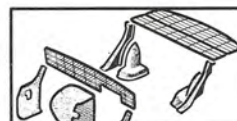

84.70 A

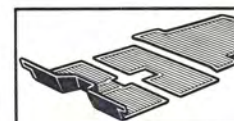

84.90 A

84

85

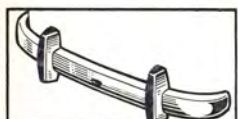

85.01 A — 85.10 A

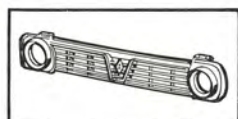

85.15 A



85.20 A



85.30 A — 85.32 A



85.35 A

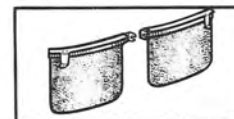

85.38 A

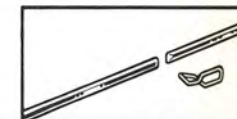

85.40 A

85



85.45 A



85.48 A

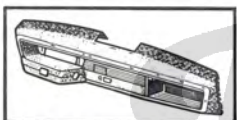

85.50 B — 85.53 A
85.60 A

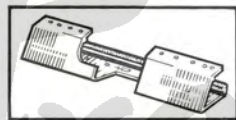

85.55 A — 85.65 A

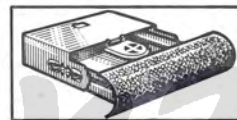

85.70 A

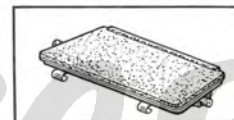

85.75 A



85.80 A

85
100
120

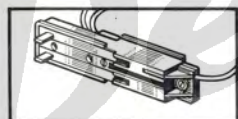

85.85 A

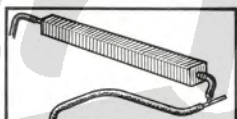

85.90 B



85.95 A



100.01 . . . A

RC23100252	5201	04	80240
RC23100252	5202	04	80240
RC23100302	1430	04	80240
RC23100302	1430	1C	80240
RC23100302	1870	02	80240
RC23100302	1875	02	80240
RC23100302	3105	10	80240
RC23100302	3130	01	80240

120.01 . . . A

85
100
120



14.20

B P.R. 880

14.20

B P.R. 880



[A=37,75] 09 80 608 200
[A=38] 09 80 608 300

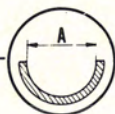

[A=2] 09 80 634 300
[A=2,05] 09 80 634 400
[A=2,10] 09 80 634 500
[A=2,15] 09 80 634 600

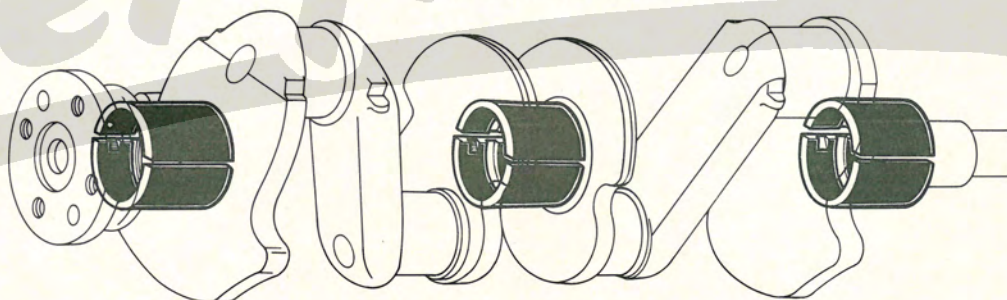
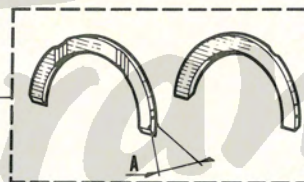

[A=39,75] 77 01 451 909
[A=40] 77 01 451 908

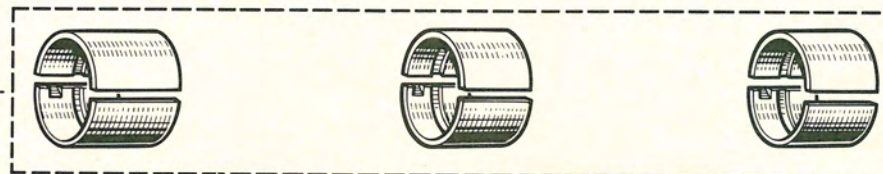
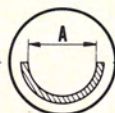

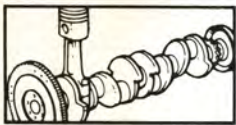

14.50

B P.R. 880

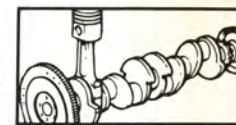

14.50

B P.R. 880

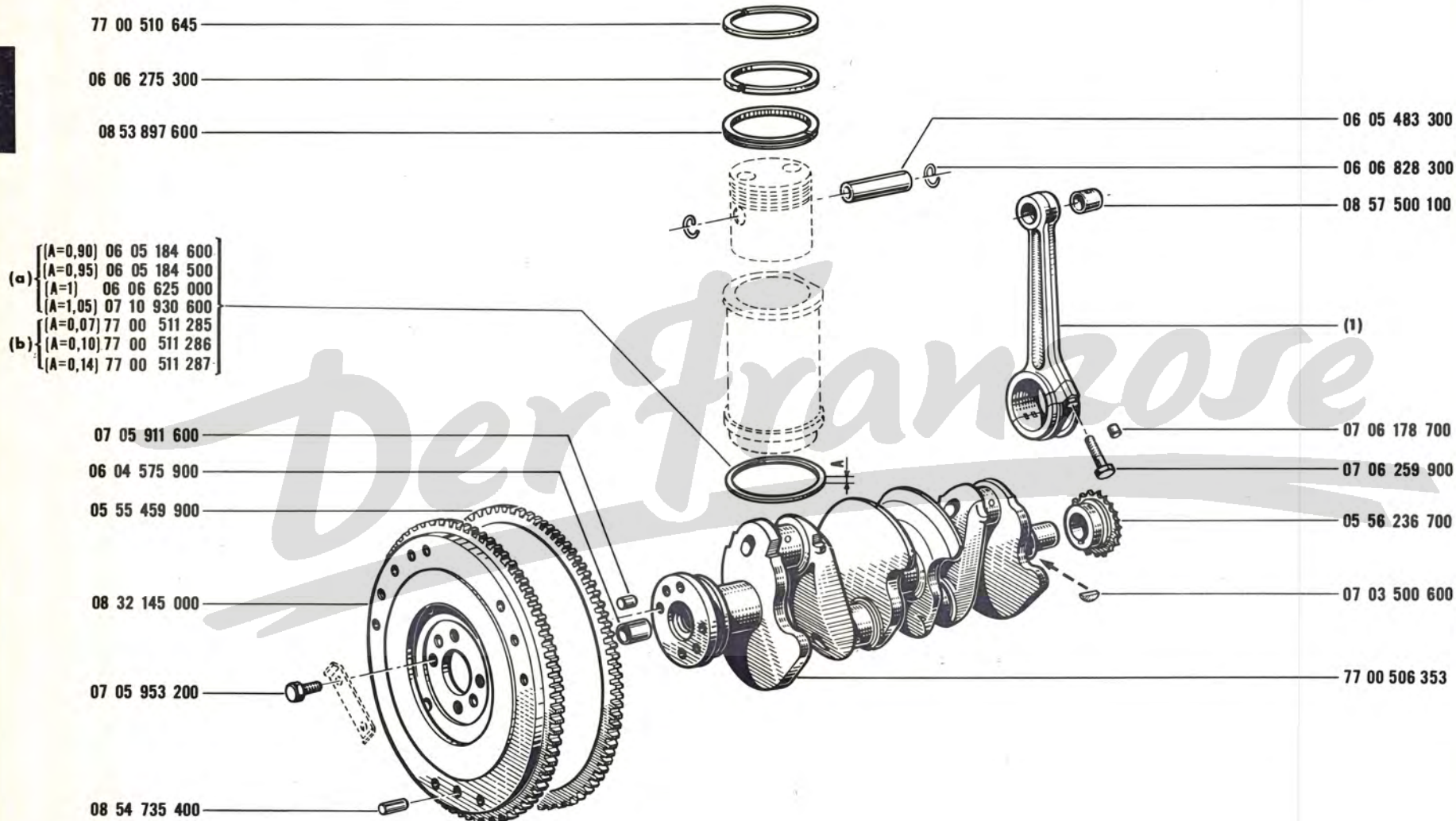

(a)	MOT 800-02 n°	1	⇨	MOT n° 11209
(b)	MOT 800-02 n°	11210	⇨	MOT n° ...

(1)	
09 80 358 751 g=328 [8]	09 80 358 770 g=368 [10]
09 80 358 790 g=338 [9]	09 80 358 730 g=378 [11]
09 80 358 740 g=348 [7]	

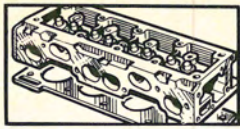

15 .01

B P.R. 880



15 .01

B P.R. 880

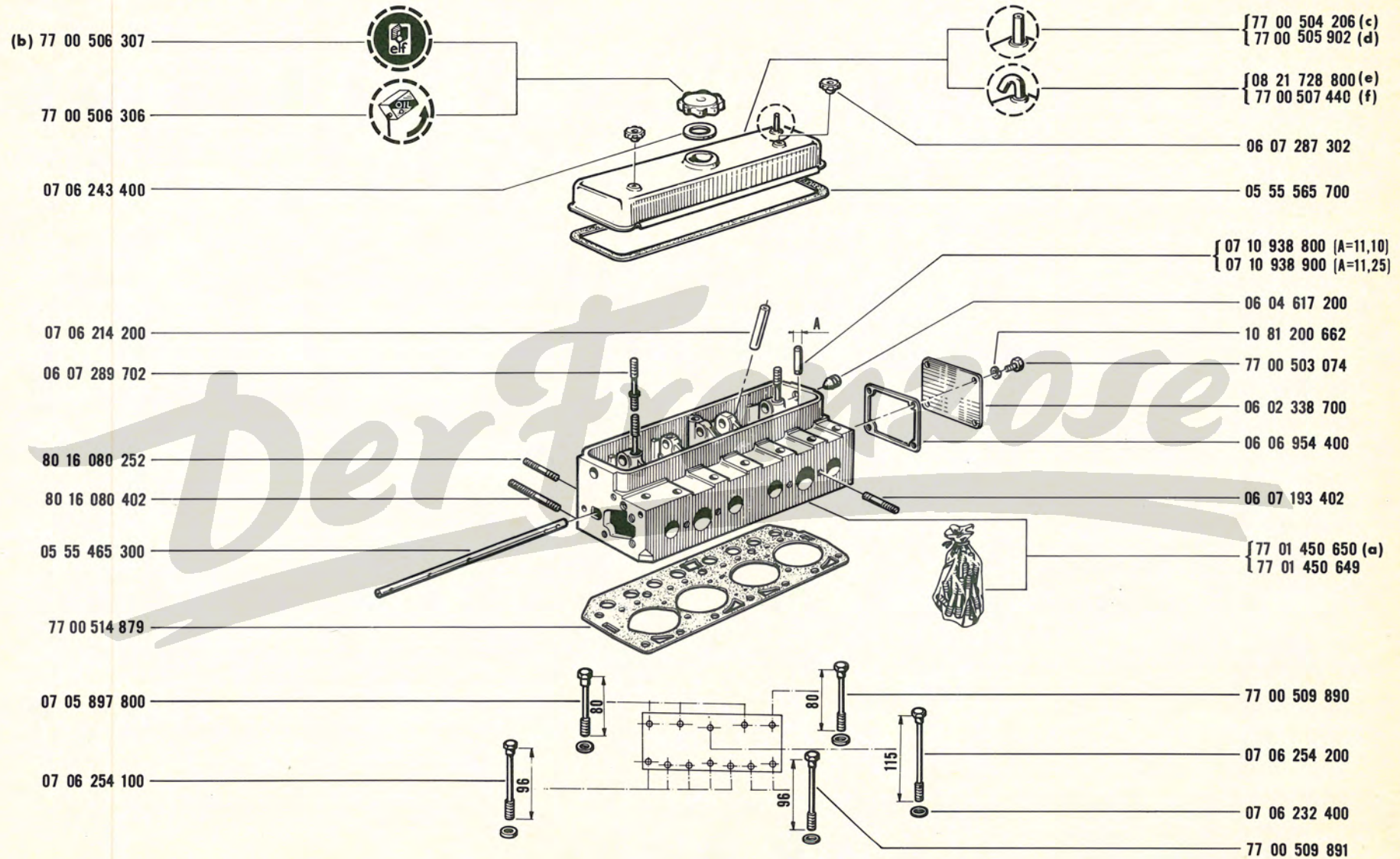

(a)	R 1180 /511/531
(b)	R 1180 /100/101/102/121/123/200/202/702
(c)	R 1180 /100/101/102/120/121/122/123/124/125/126/245
(d)	R 1180 /700/701/702

(e)	R 1180 /200/201/202/203/205/207/220/221/240/241/242/246 500/501/502/503/504/505/507/511/521/531/550
(f)	R 1180 /600/601/602/603/604/605/607/621/800

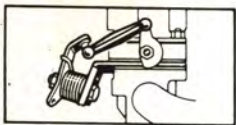

15.80

B P.R. 880

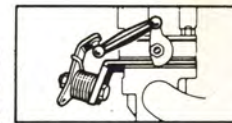

15.80

B P.R. 880

08 54 694 400

10 81 110 852

06 08 158 200

77 00 509 591

77 00 505 027
77 00 505 901

77 03 001 315 †
77 00 503 586

80 80 100 452

77 00 503 558

06 05 751 400

07 06 241 602

10 81 310 882

06 07 059 202

06 07 332 300

77 00 505 026

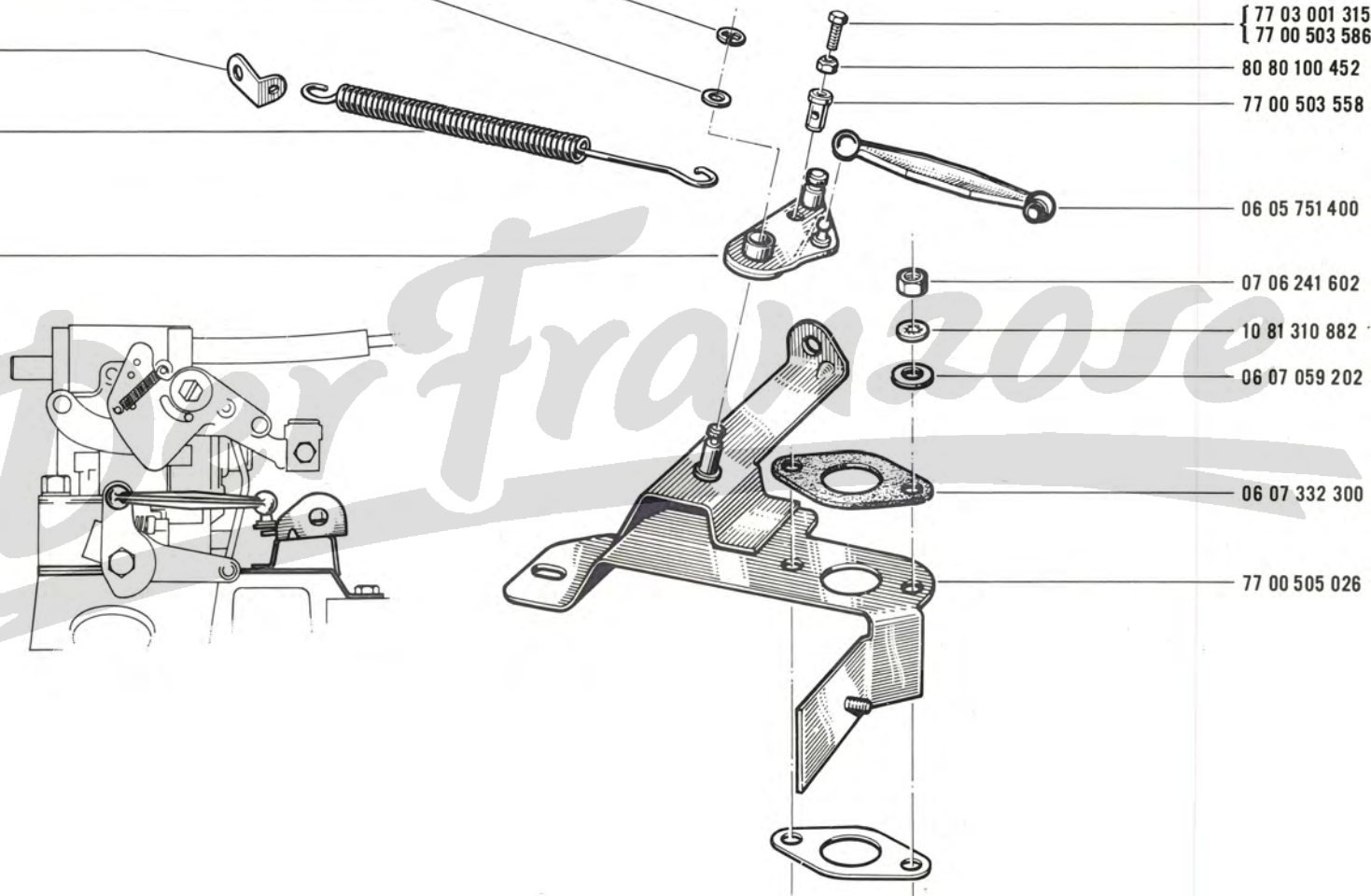

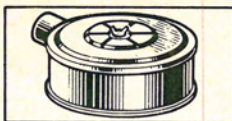

15 .87

A P.R. 880

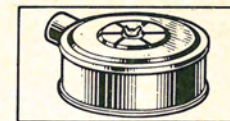

15 .87

A P.R. 880

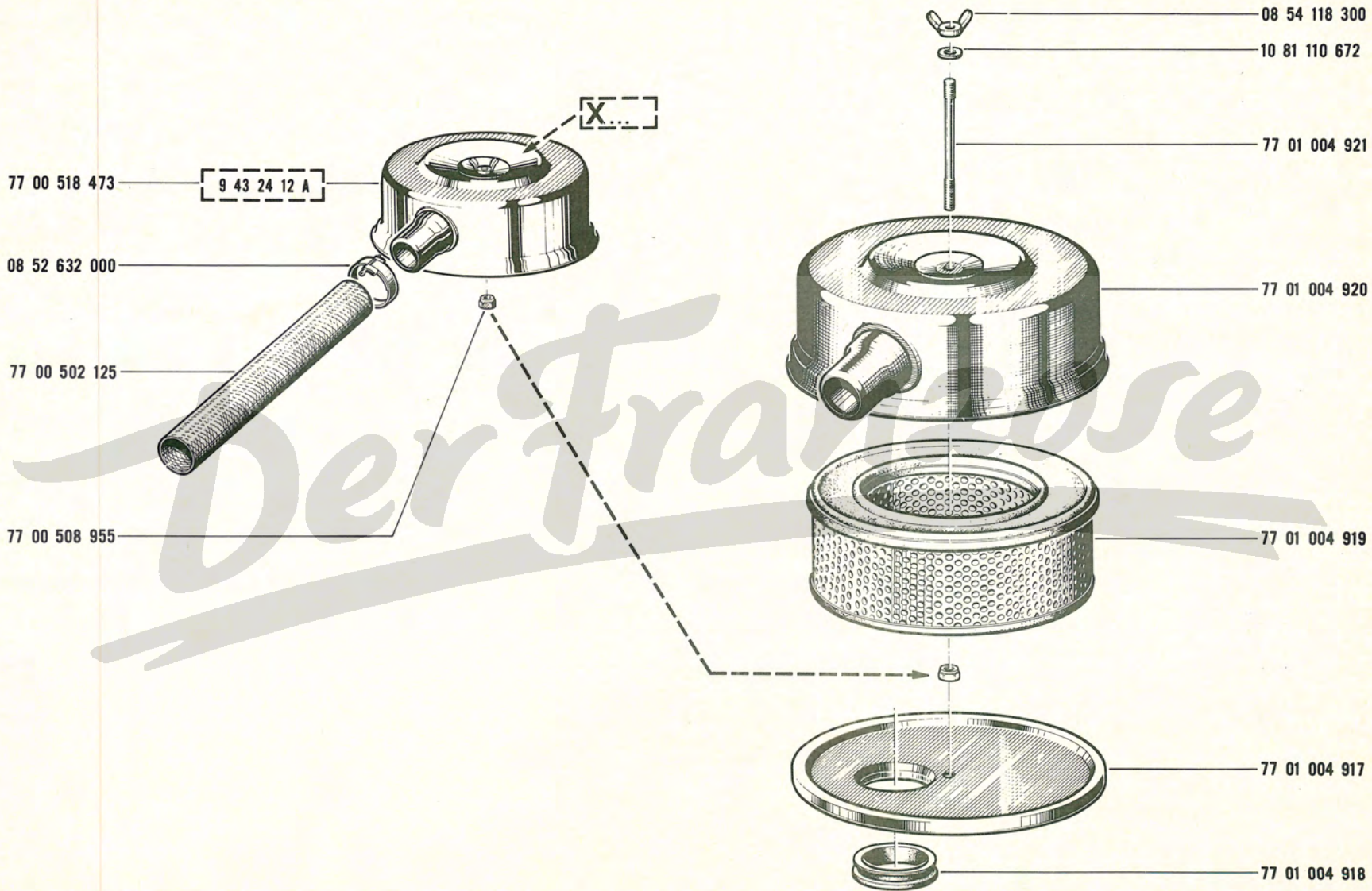

Der Franchise

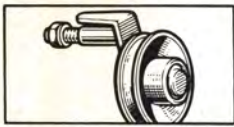

17.20

B P.R. 880

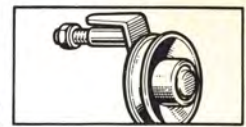

17.20

B P.R. 880

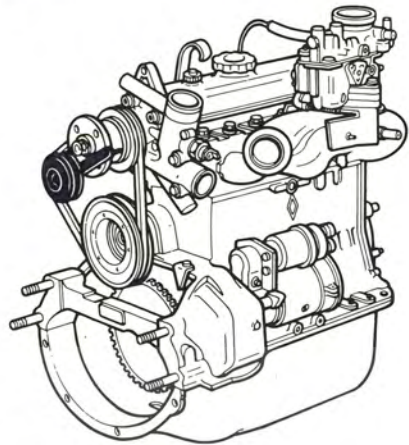

(a) †09 80 696 400 }
(3)(b) †77 01 500 045 }
(b) 77 01 452 128 }

06 03 322 800

(10×26×8) 07 70 600 001

08 51 192 700

06 07 159 402

08 51 590 300

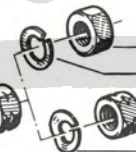
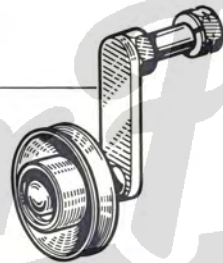

07 05 010 402 } (a)
10 81 210 262 }

77 00 511 817 } (b)
77 00 513 150 }

{ 08 24 496 700 † (a)
77 00 505 575 † (b) (3)
77 01 452 129 (b)

07 05 716 200

08 24 382 702

(a) MOT 800-02 n° 1 ⇨ MOT n° 7647

(b) MOT 800-02 n° 7648 ⇨ MOT n° ...

(3) MOT 800-02 n° 1 ⇨ MOT n° 7647

 77 00 511 817 -I-
77 00 513 150 -I-

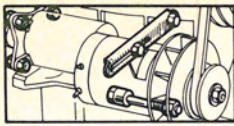

18.80

B P.R.880

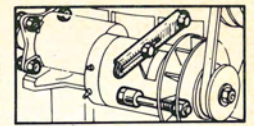

18.80

B P.R.880

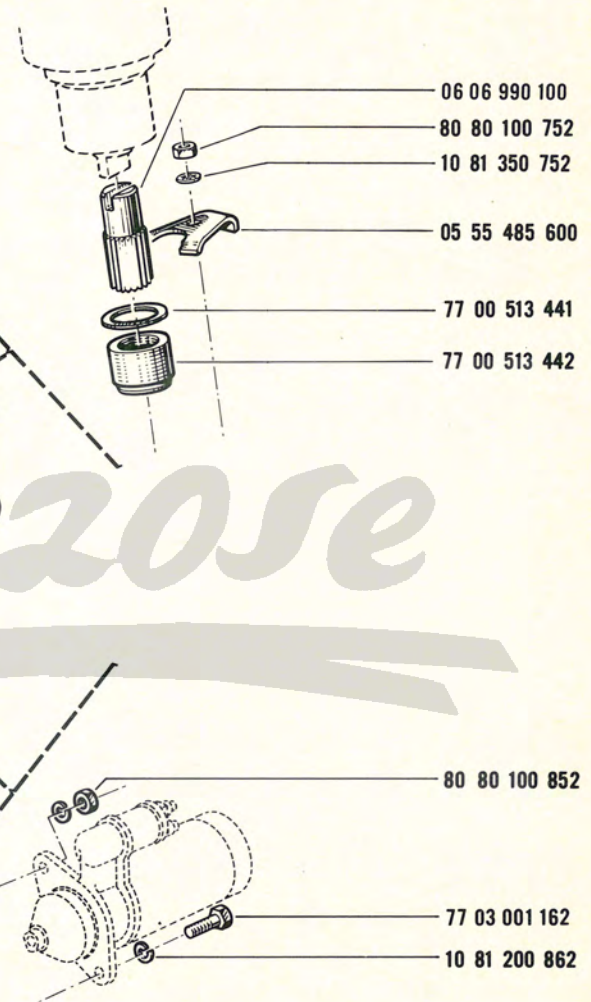
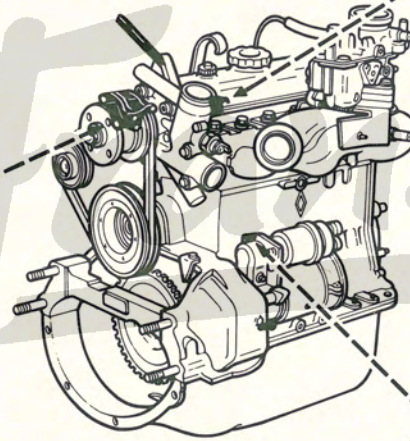
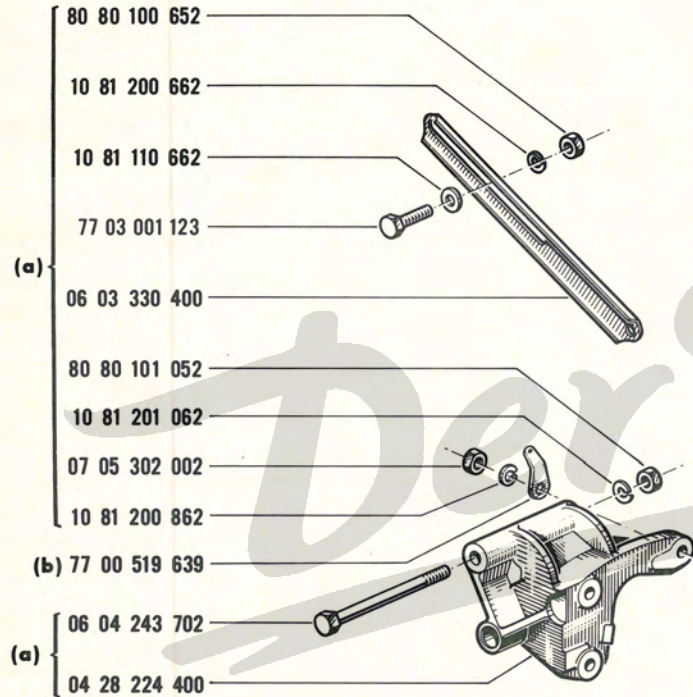

(a) R.1180 ☒ /240/241/242/245/246/550

(b) R.1180 VEH n° 9597 ☐ VEH n° . . .

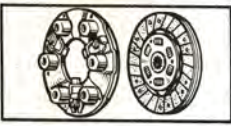

30.01

B P.R.880

30.01

B P.R.880

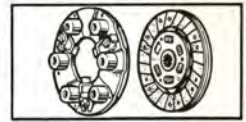

77 03 001 138

10 81 200 762

77 00 502 210 }
77 01 499 000 }

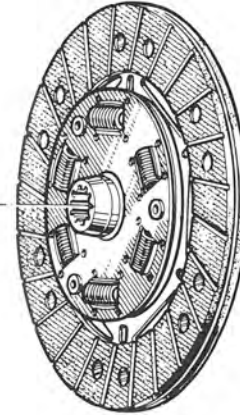
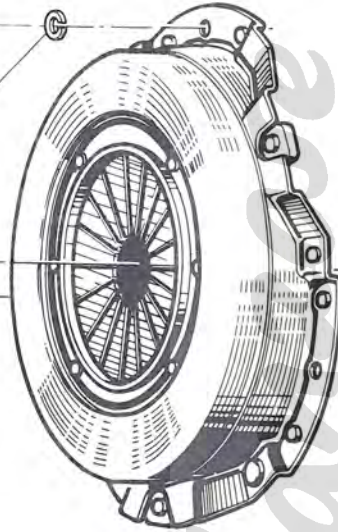

{ 77 00 501 752
77 01 004 459 }

77 01 001 328

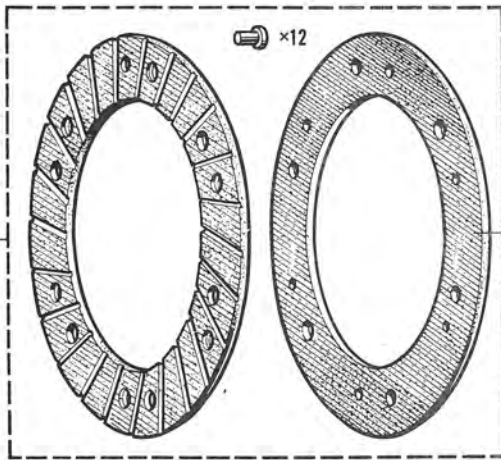

08 54 318 300

08 53 958 300

08 54 318 300

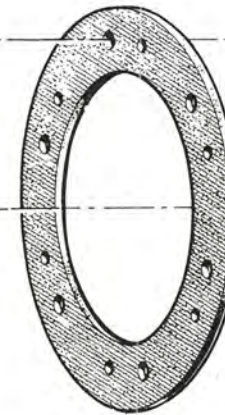
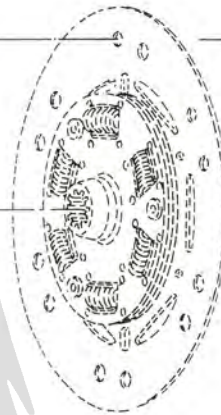

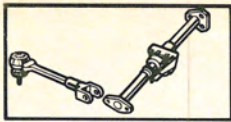

40.10

B P.R. 880

40.10

B P.R. 880

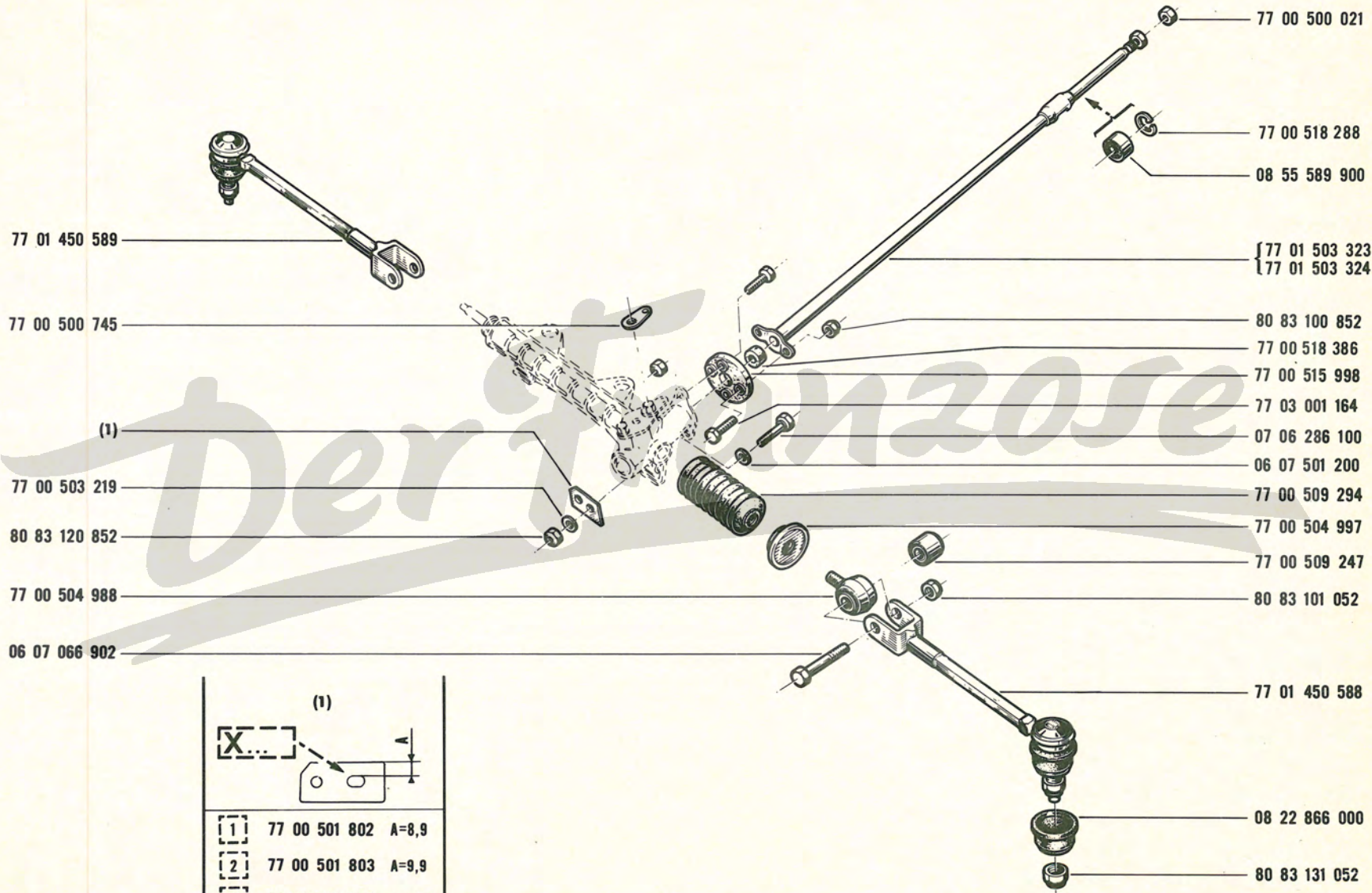
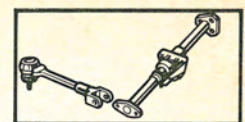

(1)

[1]	77 00 501 802	A=8,9
[2]	77 00 501 803	A=9,9
[3]	77 00 501 804	A=10,9
[4]	77 00 501 805	A=11,9
[5]	77 00 501 806	A=12,9
[6]	77 00 501 807	A=13,9
[7]	77 00 514 443	A=14,9

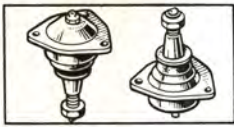

42.05

A P.R. 880

42.05

A P.R. 880

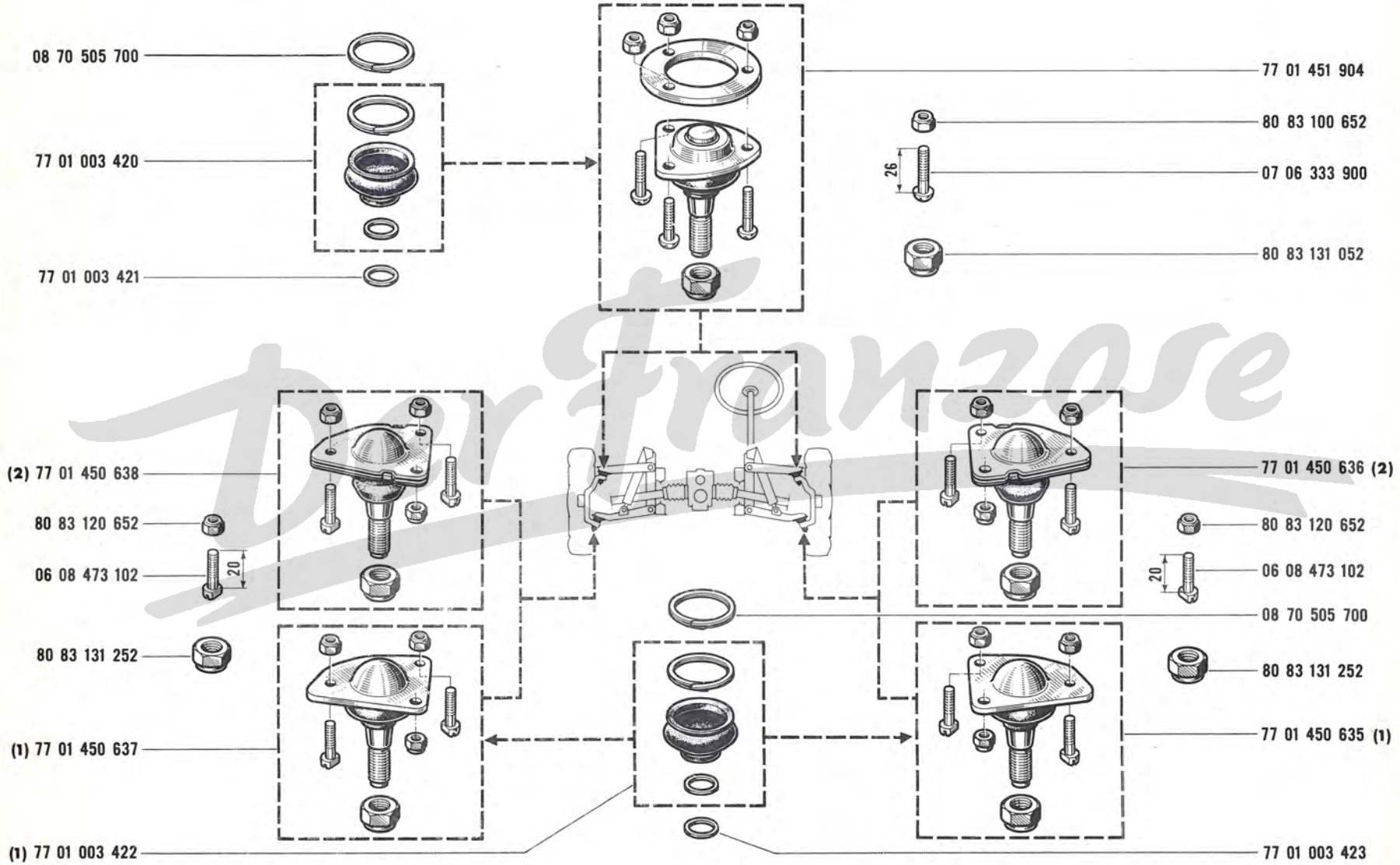
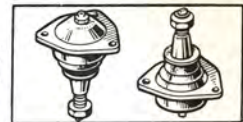

(1) EHRENREICH
(2) GEMMER

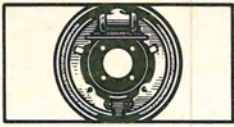

43.40
B P.R.880

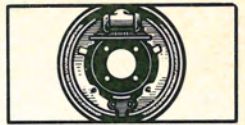

43.40
B P.R.880

(1)(3) 08 55 491 700
(2)(4) 77 01 005 436

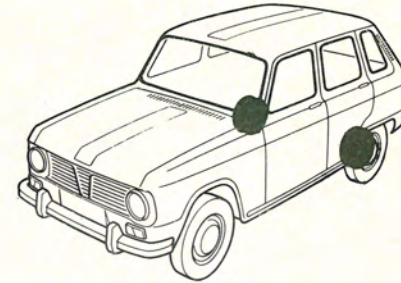
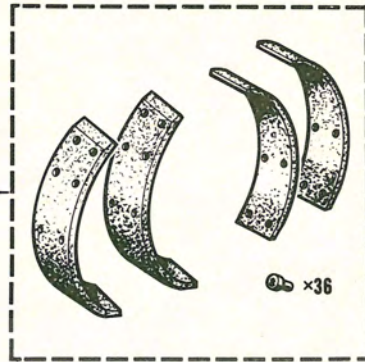

77 01 004 720

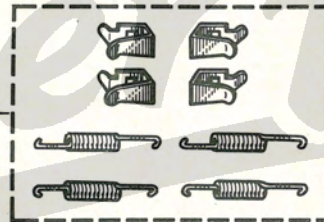

08 70 526 100

(1) { 09 81 709 000 }
{ % 09 81 709 099 }
(2) { 77 01 005 431 }
{ % 77 01 499 006 }
08 51 203 400

(3) 08 54 636 800
(4) 77 01 005 434

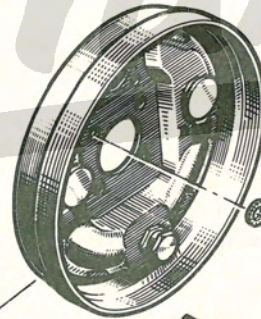

10 81 350 732

07 06 277 500

{ 08 54 636 900 (1) }
{ 77 01 005 435 (2) }

{ 09 81 709 100 }
{ 09 81 709 199 % }
{ 77 01 005 433 }
{ 77 01 499 007 % }

08 54 958 100

77 01 004 719

08 54 905 900

(1) 09 81 709 100 - 09 81 709 199

(2) 77 01 005 433 - 77 01 499 007

(3) 09 81 709 000 - 09 81 709 099

(4) 77 01 005 431 - 77 01 499 006



44.01

B P.R. 880

44.01

B P.R. 880



08 30 806 500

DUNLOP

08 55 733 700

FERGAT

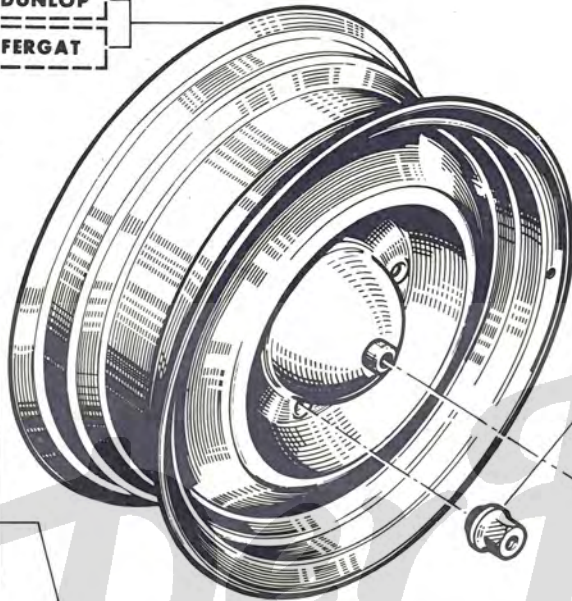

08 54 802 100 (10g)

08 54 802 200 (15g)

08 54 802 300 (20g)

08 54 802 400 (25g)

08 54 802 500 (30g)

08 54 802 600 (35g)

08 54 802 700 (40g)

08 54 802 800 (45g)

08 54 802 900 (50g)

08 54 803 000 (55g)

08 54 803 100 (60g)

08 54 803 200 (70g)

08 54 803 300 (80g)

08 54 803 400 (90g)

08 54 803 500 (100g)

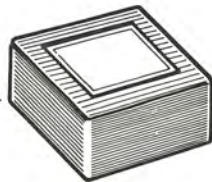

05 55 486 900



77 01 451 906

77 00 500 534

07 06 305 004

07 60 707 800 (A=600) ▶◀ 3m50



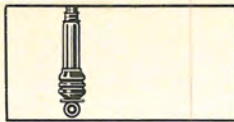

51.40

B P.R. 880

51.40

B P.R. 880

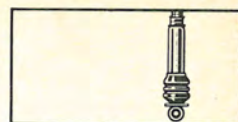

- (a) 77 00 511 044
- (b) 77 00 515 540
- (c) 77 00 515 542

- 77 00 511 044
- 77 00 515 540
- 77 00 515 542

- 08 52 278 300
- 08 55 710 600
- 08 54 503 500
- 08 54 865 300
- (3) 08 55 710 400
- (1) (2) 08 54 503 700

- (1) 08 54 865 300
- (2)(3) 08 55 710 300
- (3) 77 01 003 846
- (1) 08 54 503 500
- (2) 08 70 400 800

- 08 70 238 300
- (1) 06 08 272 800
- † 77 01 003 467
- 08 70 238 200

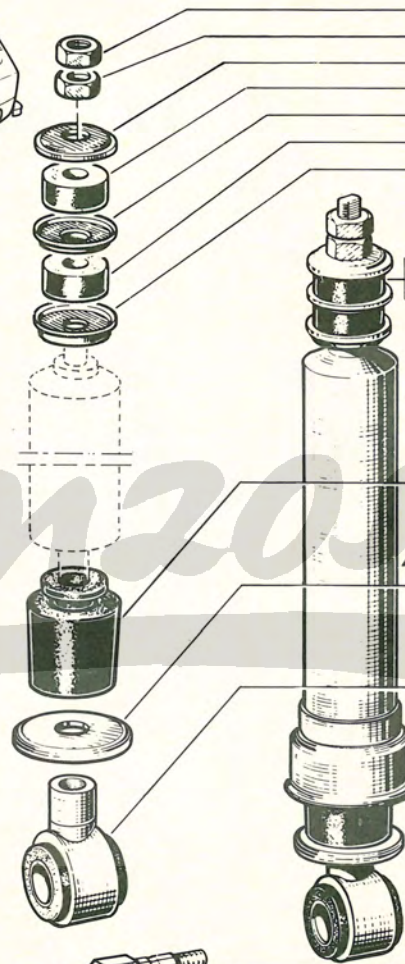
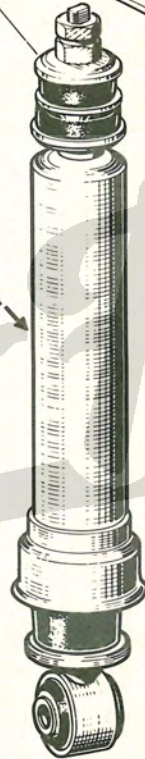
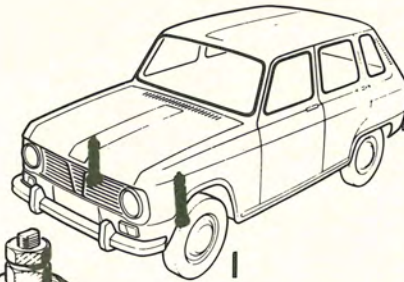

- 08 52 278 300
- 08 70 028 900
- 08 51 765 900
- 08 54 765 200
- 08 51 765 800
- 08 54 766 100
- 08 51 765 900

- 77 00 515 544 (a)
- 8557913 (d)

- 08 70 237 100
- 08 70 237 200
- 08 70 237 300

- 08 33 205 600
- 10 81 111 252
- 77 00 501 325
- 77 00 501 325
- 10 81 111 052
- 80 83 101 052

- (a) R 1180 /100/101/102/120/121/122/123/124/125/126/700/701/702
- (b) R 1180 /200/201/202/203/205/207/220/221/800
- (c) R 1180 /500/501/502/503/504/505/507/511/521/531/600/601/602/603/604/605/607/621
- (d) R 1180 /240/241/242/245/246/550

- (1) 77 00 511 044
- (2) 77 00 515 540
- (3) 77 00 515 542

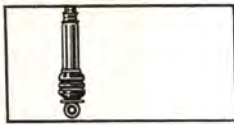

51.50

B P.R. 880

51.50

B P.R. 880

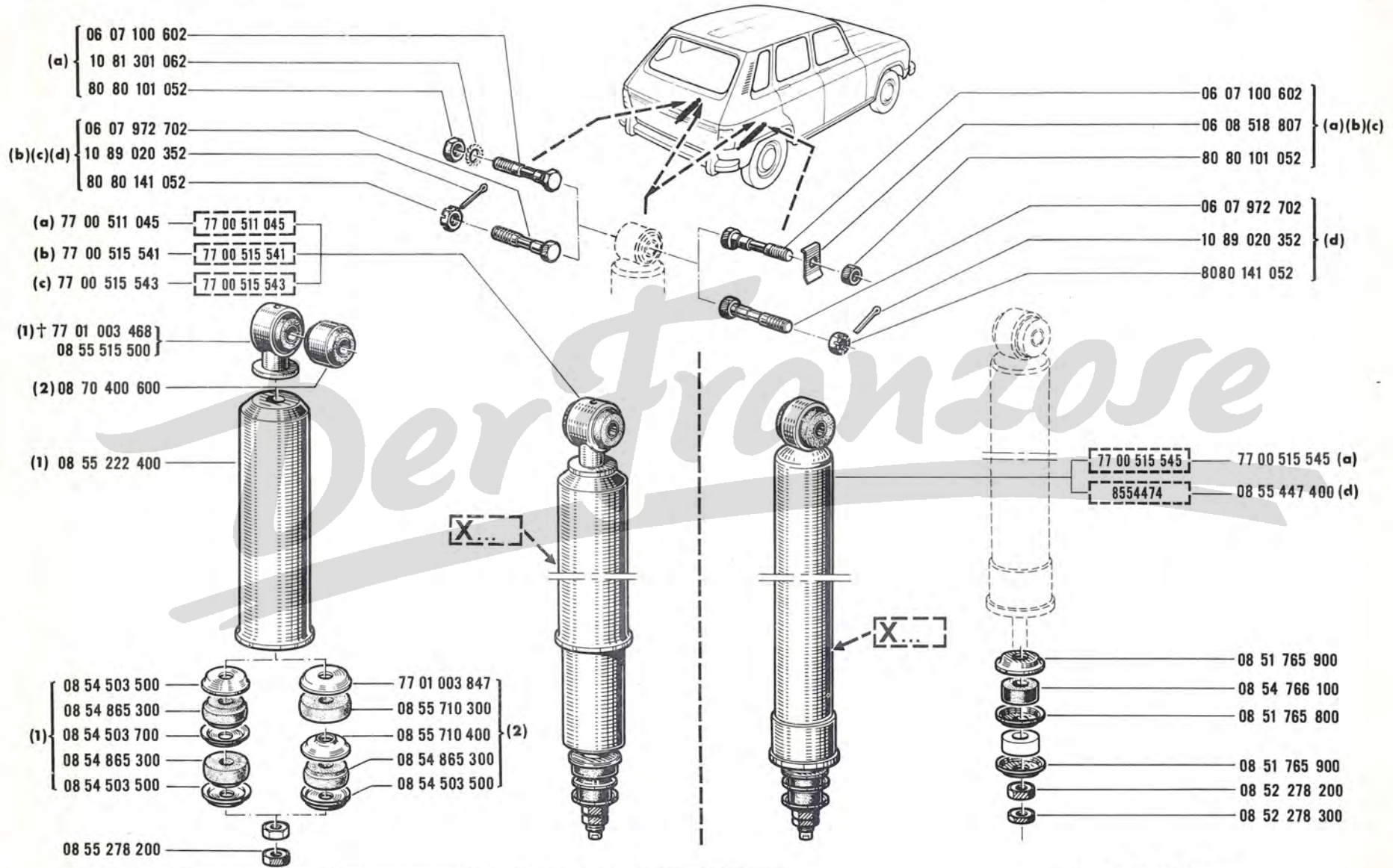
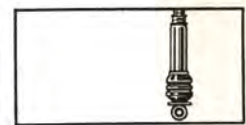

- (1) ☒ 77 00 511 045
- (2) ☒ { 77 00 515 541, 77 00 515 543 }

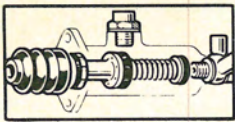

58.25

B P.R. 880

58.25

B P.R. 880

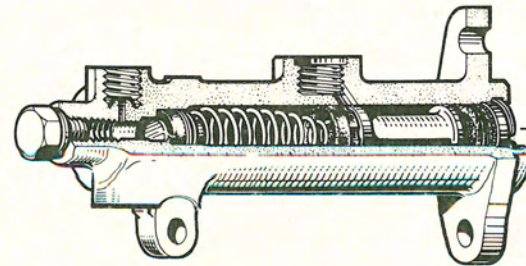
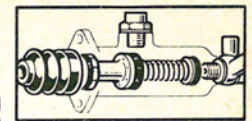

77 00 516 541

77 01 004 222

08 55 609 800

08 55 610 100

08 55 609 700

77 01 004 057

77 01 001 590

77 01 004 058

08 54 800 400

77 01 004 221

77 01 004 223

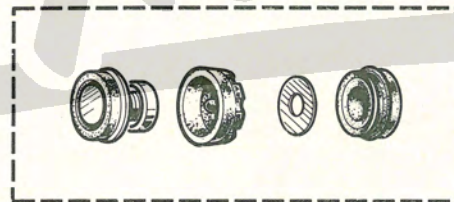

08 55 610 300

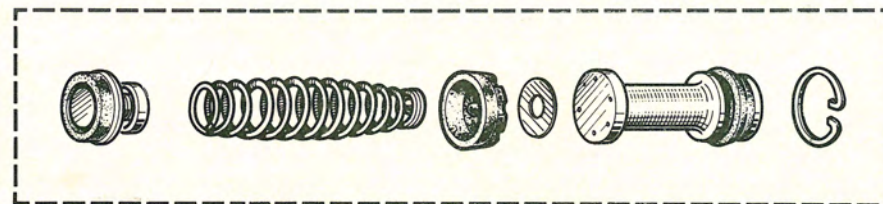

77 01 004 105

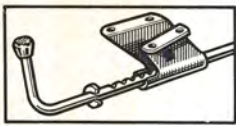

58.55

B P.R. 880



58.55

B P.R. 880

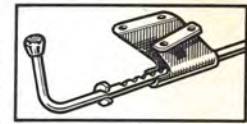

05 56 419 200

07 06 347 300

77 00 511 650

80 23 070 152

10 81 200 762

08 22 808 700

77 00 516 540

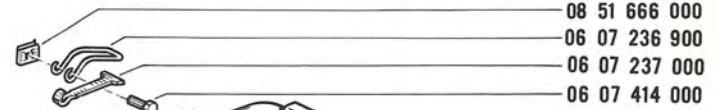

08 51 666 000

06 07 236 900

06 07 237 000

06 07 414 000

77 00 507 114

77 00 518 427 } (R.1180 /120)

08 32 141 400

06 07 171 400

08 32 100 000

10 81 200 662

80 80 100 652

05 56 397 200

08 33 164 600

07 05 322 000

06 07 110 900

08 24 376 400

07 03 621 300

10 89 020 150

Der Franzose



58.70

B P.R. 880



58.70

B P.R. 880

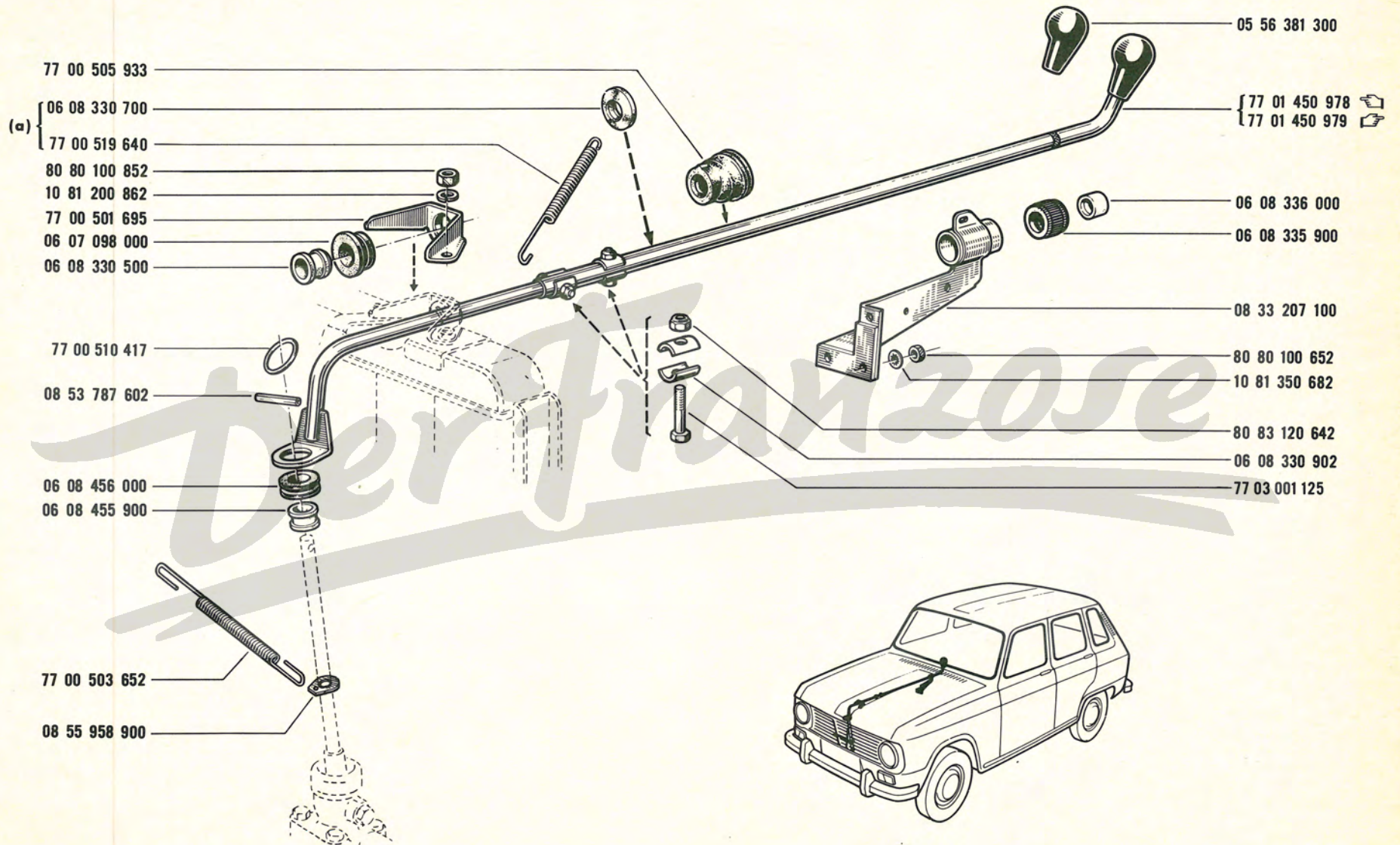

(a) R.1180 VEH n° 9597 ⇨ VEH n° ...



61.02

A P.R. 880

R.1180

/ 100/101/102/120/121/122/123/124/125/126/200/201
202/203/205/207/220/221/241/242/245/246/500/501
502/503/505/507/511/521/531/550/601/604/607/621/702

61.02

A P.R. 880



77 00 518 526

ED-VEGLIA

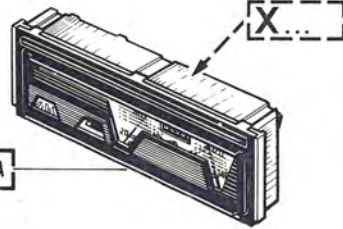

77 01 004 859

77 01 004 857

77 01 004 856

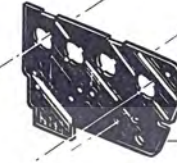
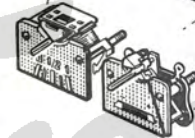
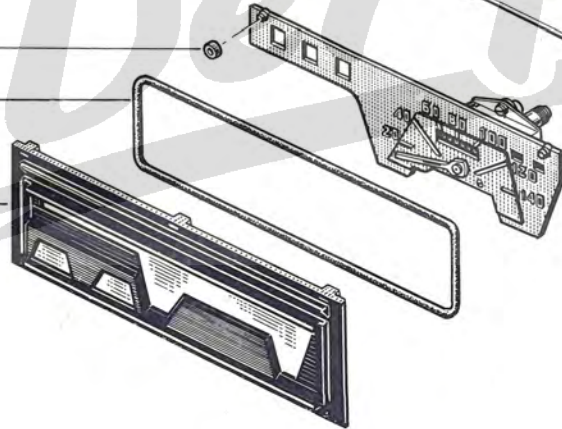

77 01 004 861

08 55 132 200 (12V-2W)

77 01 004 864

80 80 100 352

77 01 004 865

08 54 808 800 (12V-4W)

80 80 100 352

77 01 004 936

77 01 004 863

77 01 004 862

80 70 040 109

08 54 860 100

77 01 004 860

77 01 004 858

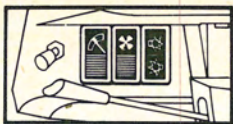

61.05

B P.R. 880

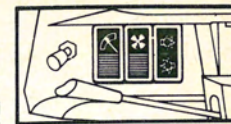

61.05

B P.R. 880

77 00 509 368
≠
77 00 511 903
≠
08 55 967 800

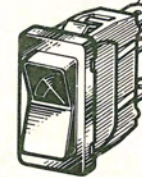
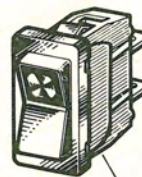
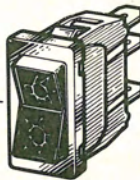

08 55 870 600
≠
08 55 839 300
≠
08 55 870 500

77 03 001 112
08 70 051 200
08 70 051 100

77 00 509 330

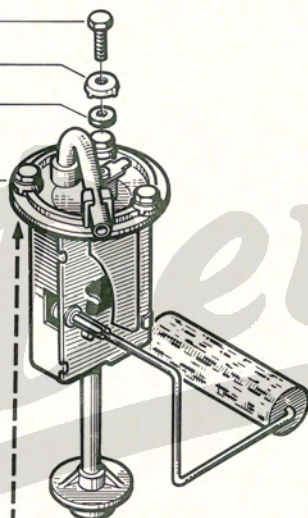

08 57 579 500



77 00 511 904
≠
77 00 511 902
≠
08 55 967 700

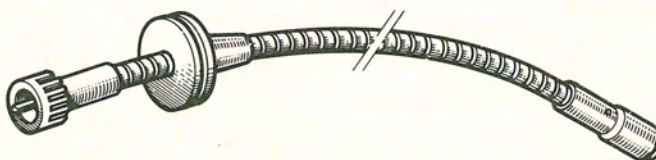

{ 77 00 508 327 (A=1,280m)
77 00 512 538 (A=1,820m)

{ 77 00 518 527 (A=1,280m)
77 00 518 659 (A=1,820m)

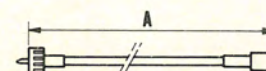

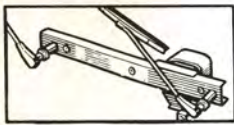

61.35

B P.R.880

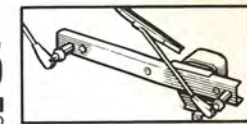

61.35

B P.R.880

77 01 003 756

77 01 003 760

77 00 504 491

77 01 003 758

77 01 003 759

77 01 004 802

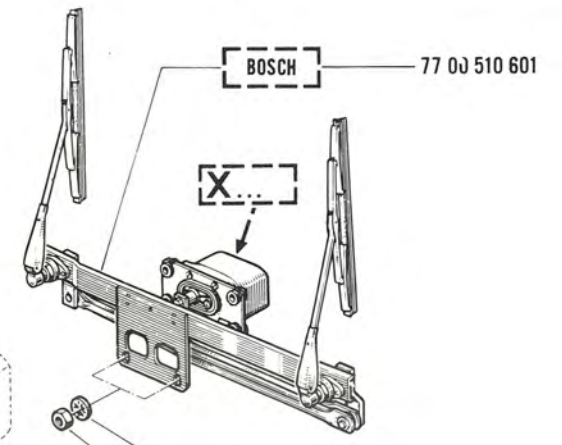

BOSCH

77 00 510 601

X

10 81 350 672

80 80 100 652

77 01 003 755

80 23 040 102

10 81 110 452

77 01 003 757

08 70 421 800

08 70 421 900

08 55 713 200



81.40

B P.R. 880

81.40

B P.R. 880

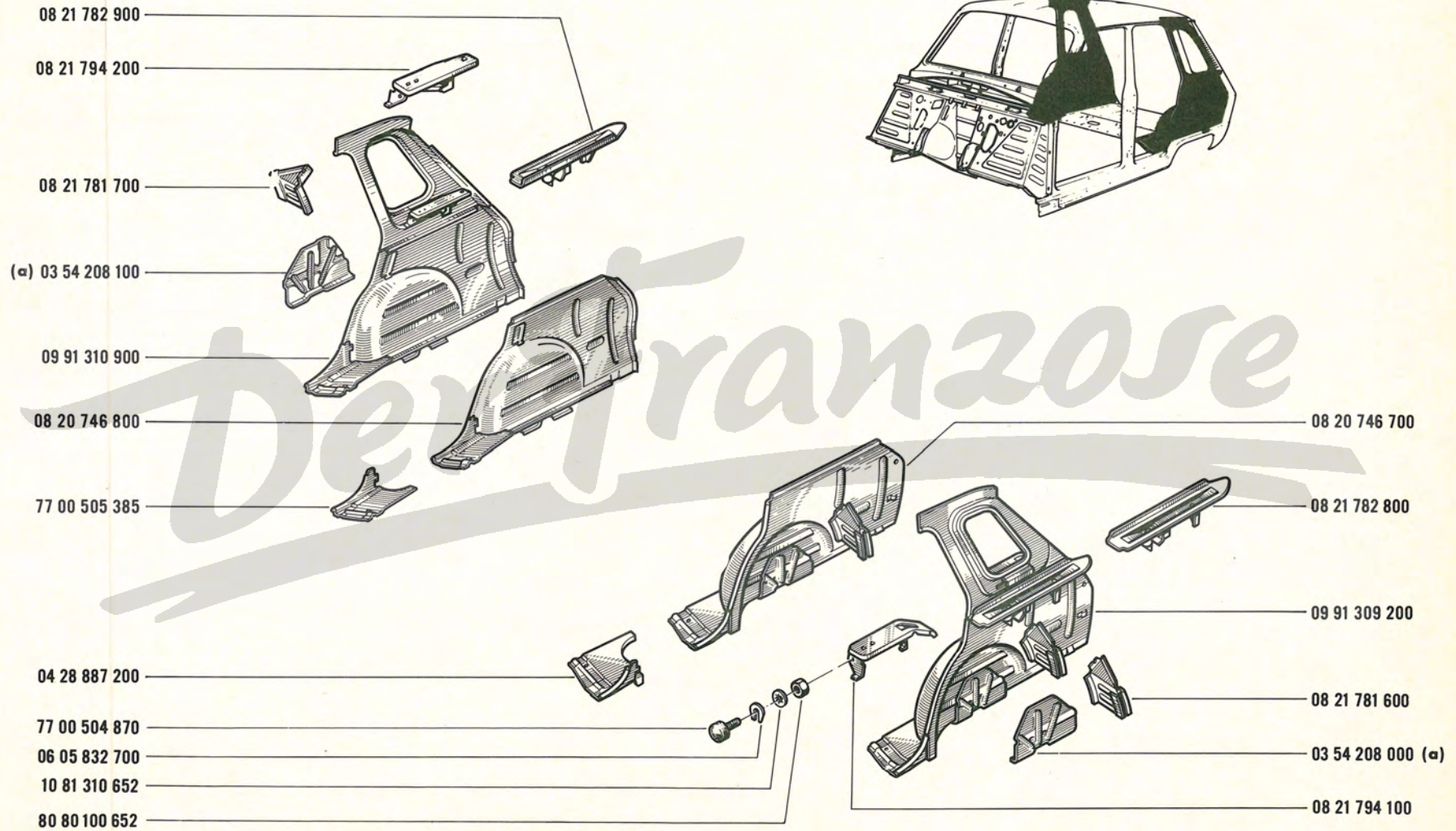

(a) R 1180 / 200/201/202/203/205/207/220/221/240/241/242/245/246/500/501/502/503
 504/505/507/511/521/531/550/600/601/602/603/604/605/607/621/800



81 .70

B P.R. 880

81 .70

B P.R. 880

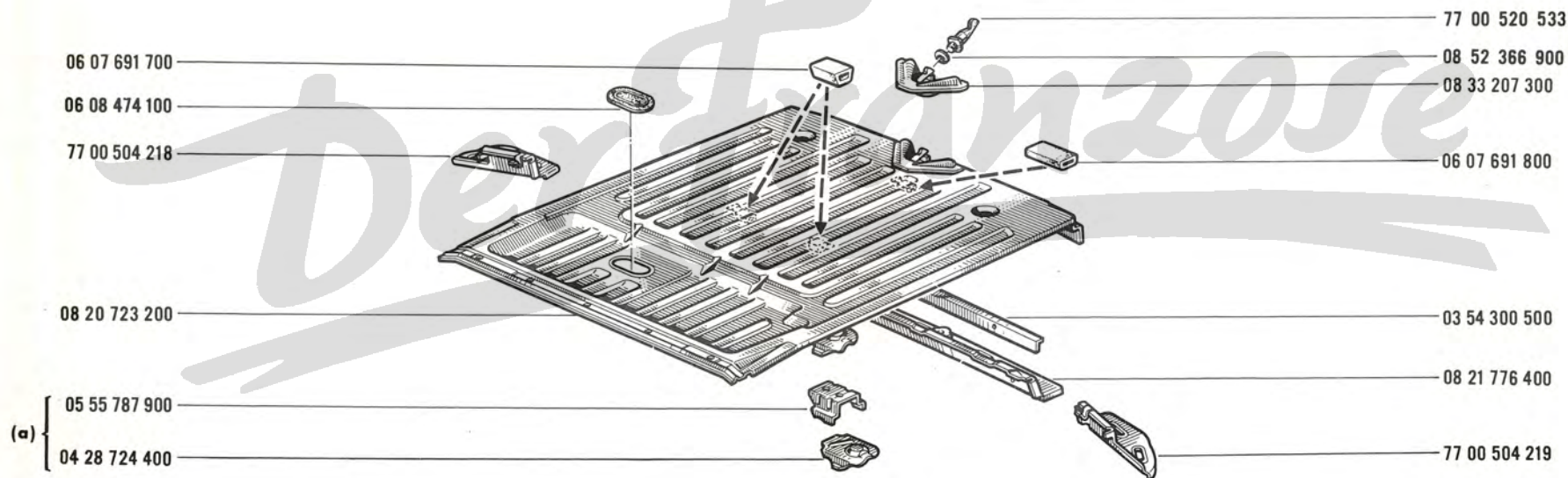
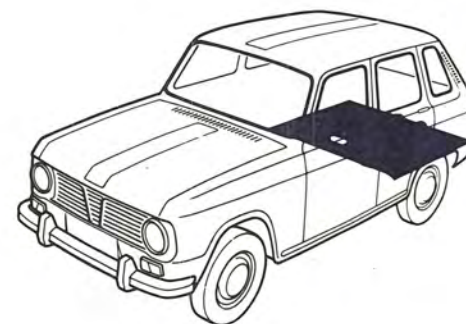

(a) R.1180 / 200/201/202/203/205/207/220/221/240/241/242/245/246/500/501/502/503
 504/505/507/511/521/531/550/600/601/602/603/604/605/607/621/800

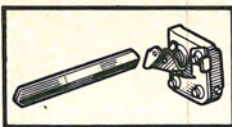

82.10

B P.R.880

82.10

B P.R.880

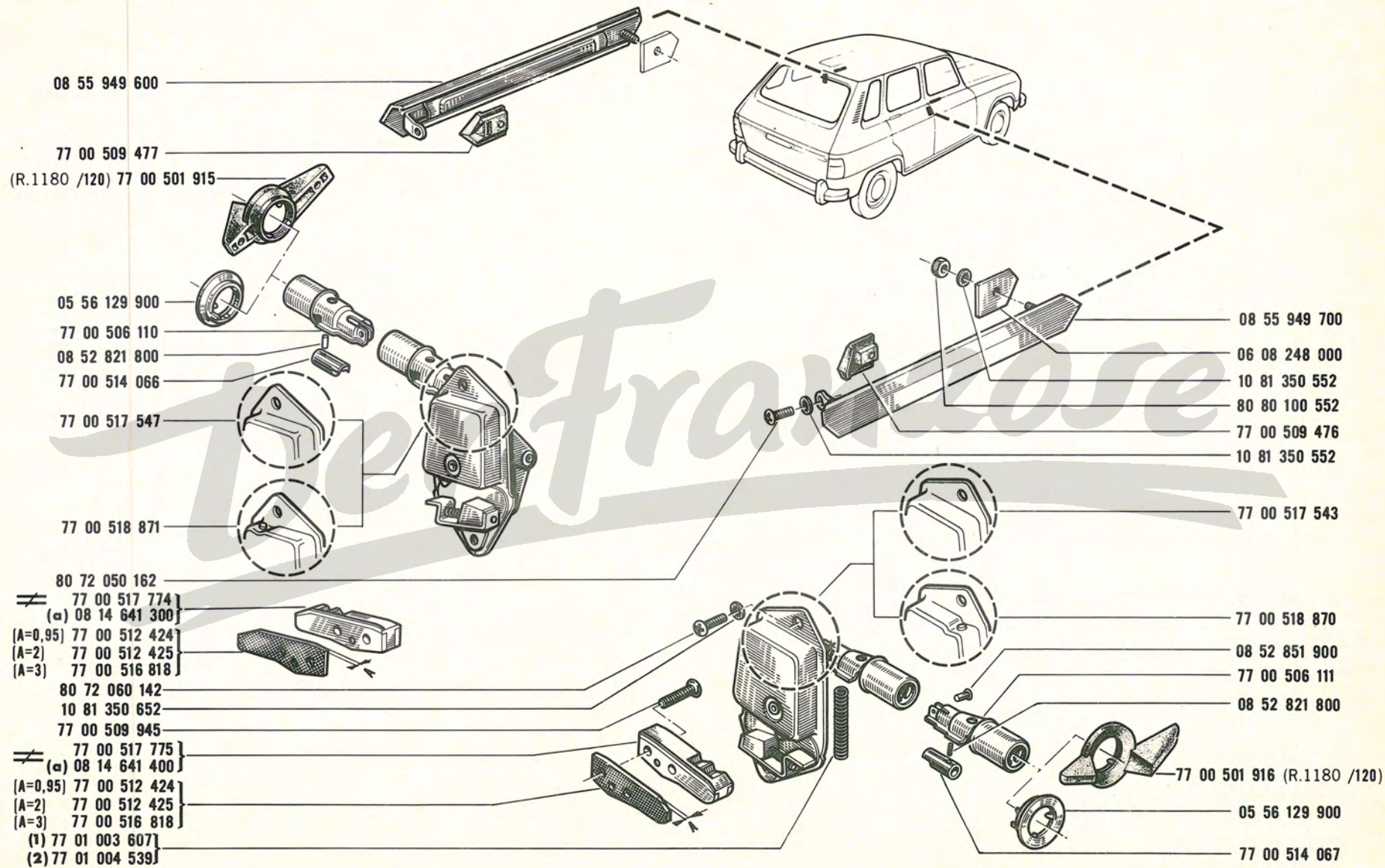

(a) R.1180 VEH n° ⇨ VEH n° . . .

(1) ~~77 00 517 543~~-77 00 517 547

(2) ~~77 00 518 870~~-77 00 518 871



82.20

B P.R. 880

82.20

B P.R. 880

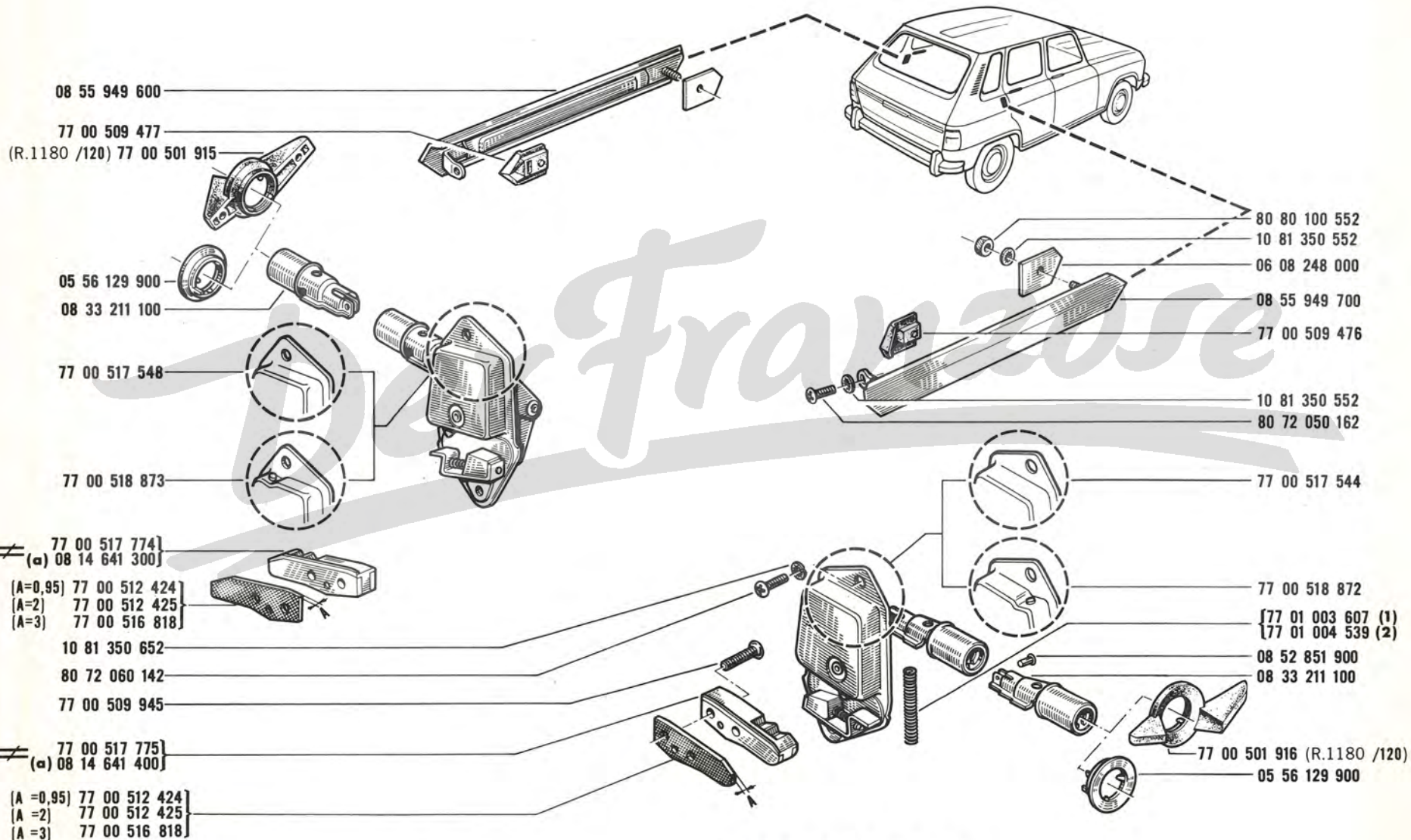

(a) R.1180 VEH n° ⇨ VEH n° . . .

(1) ↗ 77 00 517 544-77 00 517 548
(2) ↗ 77 00 518 872-77 00 518 873

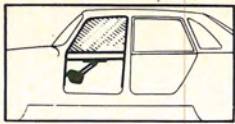

82.50

B P.R. 880

82.50

B P.R. 880

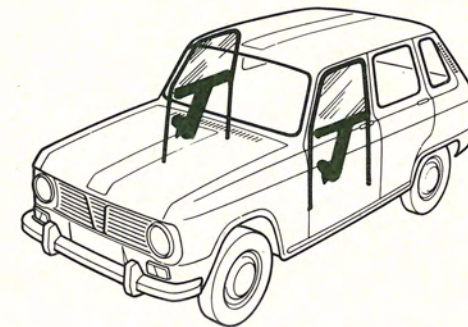
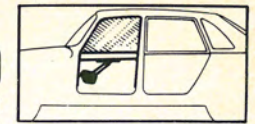

(b) † 77 00 512 686
(7) (c) 77 00 521 038
77 00 503 077

77 00 503 001
06 08 287 300
10 81 350 652
80 80 100 652
77 01 003 762
80 80 100 642
77 00 509 139
77 00 500 081
77 00 500 086

(a)	R.1180	/240/245/521/603
(b)	R.1180	VEH n° 1 ⇔ VEH n° 25194
(c)	R.1180	VEH n° 25195 ⇔ VEH n° ...

(7) R.1180 VEH n° 1 ⇔ VEH n° 25194

77 00 521 776 -6-

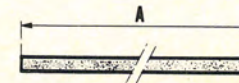

{ 08 55 785 300 (b)
77 00 521 776 (c)

{ 08 57 710 400 (a)
08 57 721 900

08 57 721 000
{ 77 00 512 687 (b)
77 00 521 039 (c) (7)
06 60 500 000 (A=580) ▶◀ 3m
77 00 503 078

77 00 503 428 (A=2175) < 1m

77 00 503 002

08 57 541 600

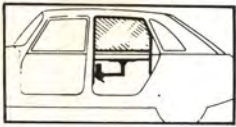

82.55

B P.R. 880

82.55

B P.R. 880

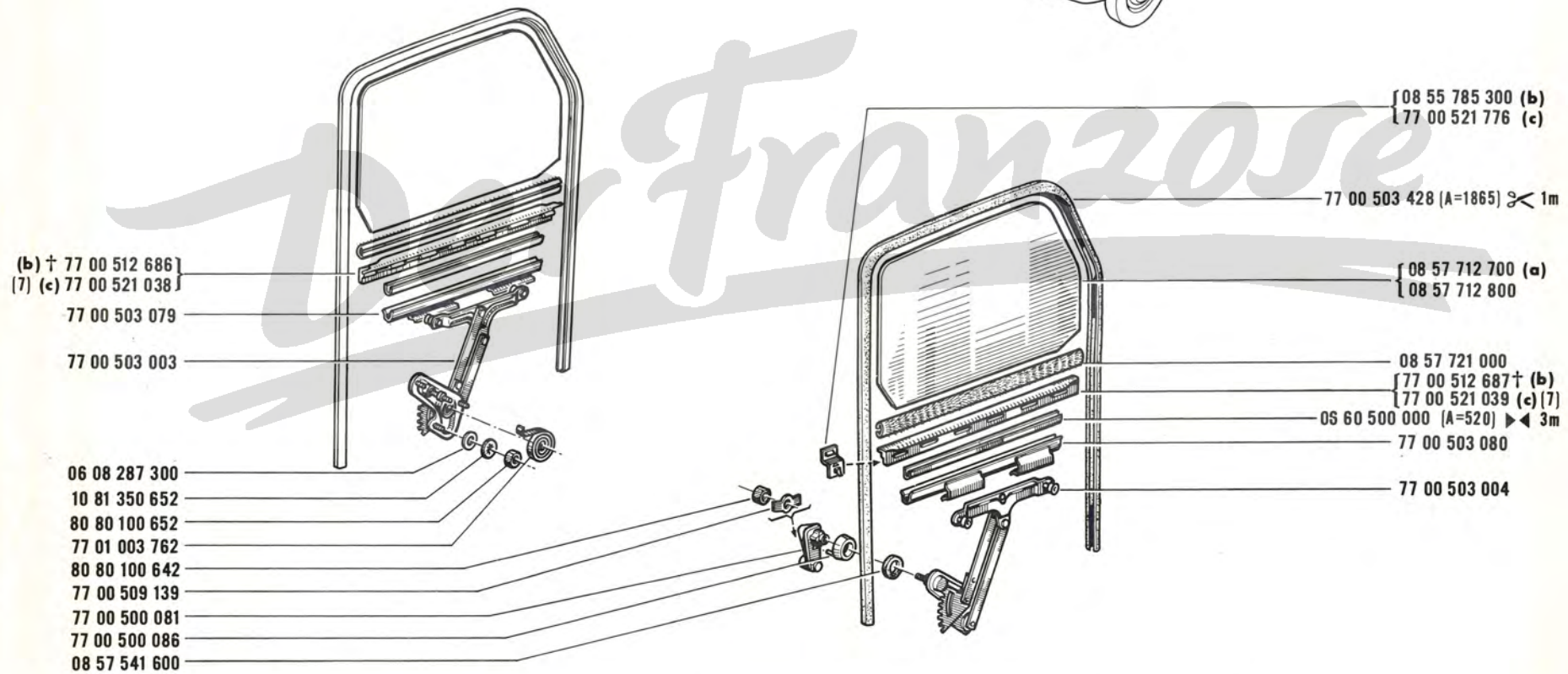

(a)	R.1180	/240/245/521/603
(b)	R.1180	VEH n° 1 ⇨ VEH n° 25194
(c)	R.1180	VEH n° 25195 ⇨ VEH n° ...

(7)	R.1180	VEH n° 1 ⇨ VEH n° 25194
		77 00 521 776 -6-

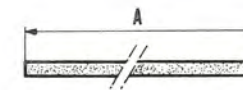



82.58

B P.R. 880



82.58

B P.R. 880

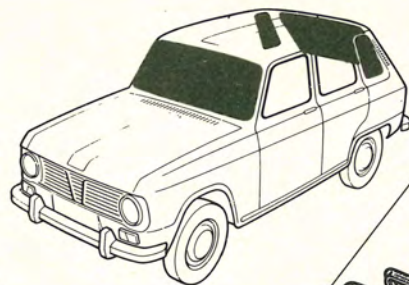

77 00 508 406



(b) † 77 00 510 358
(c) † 77 00 517 782

(b) † 77 00 510 357
(c) † 77 00 517 781

(c) 77 01 452 075

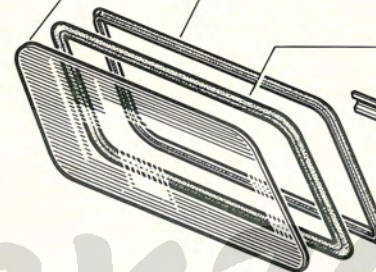

{ 08 57 710 000 (a)
08 57 713 000

07 50 752 000(A=2714) \varnothing <math><1m</math>



05 56 382 500

06 08 284 200

{ 08 57 709 900 (a)
08 57 713 100



77 00 508 405

05 56 382 600



{ 77 00 510 320 (b)
77 00 517 571 (c)

{ 77 00 510 324 (b)
77 00 517 571 (c)

\varnothing <math><1m</math>(A=3055) 07 50 752 000



{ 77 00 510 356 † (b)
77 00 517 574 † (c)

{ 77 00 510 355 † (b)
77 00 517 573 † (c)

06 08 284 200

(a) { 08 57 707 200
77 00 521 773
08 57 707 100

77 01 452 076 (c)

(a) R 1180 /240/245/521/603

(b) R 1180 VEH n° 1 ⇨ 2986

(c) R 1180 VEH n° 2987 ⇨ VEH n° ...

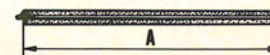



82.90

B P.R.880



82.90

B P.R.880

08 55 641 700

77 00 517 216

05 56 384 300

08 55 555 700

77 00 501 798

08 54 615 300

05 56 384 200

77 00 515 398



×12



×28

×28



06 08 451 600

08 52 259 000

10 81 110 452

77 00 509 520

06 08 518 900

77 00 509 379

77 00 509 519

06 60 482 100 ▶◀3250

06 60 482 100 ▶◀3250

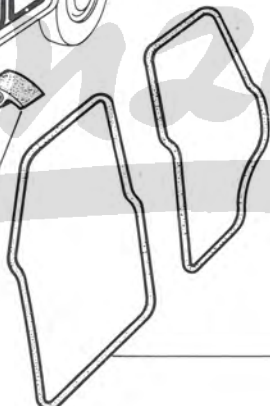
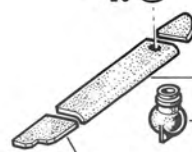
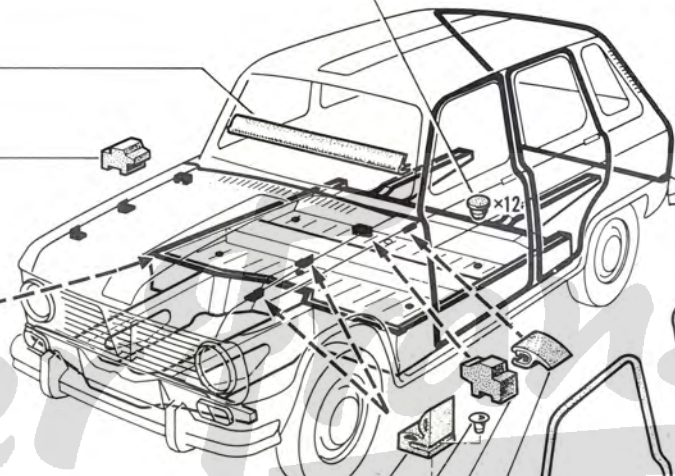
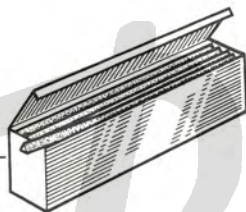

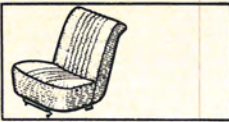

84.31

B P.R. 880

84.31

B P.R. 880

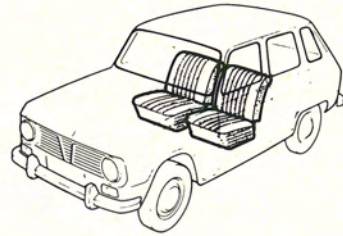
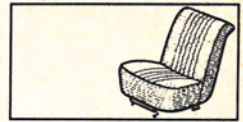

- 51 a 77 01 450 732
- 51 z 77 01 450 761
- 14 a 77 01 450 730
- 13 z 77 01 450 760
- 20 a 77 01 450 731
- 21 z 77 01 450 762

(R 1180/245) 08 57 736 100

- 51 a 77 01 450 717
- 51 z 77 01 450 746
- 14 a 77 01 450 715
- 13 z 77 01 450 745
- 20 a 77 01 450 716
- 21 z 77 01 450 747

77 00 504 316

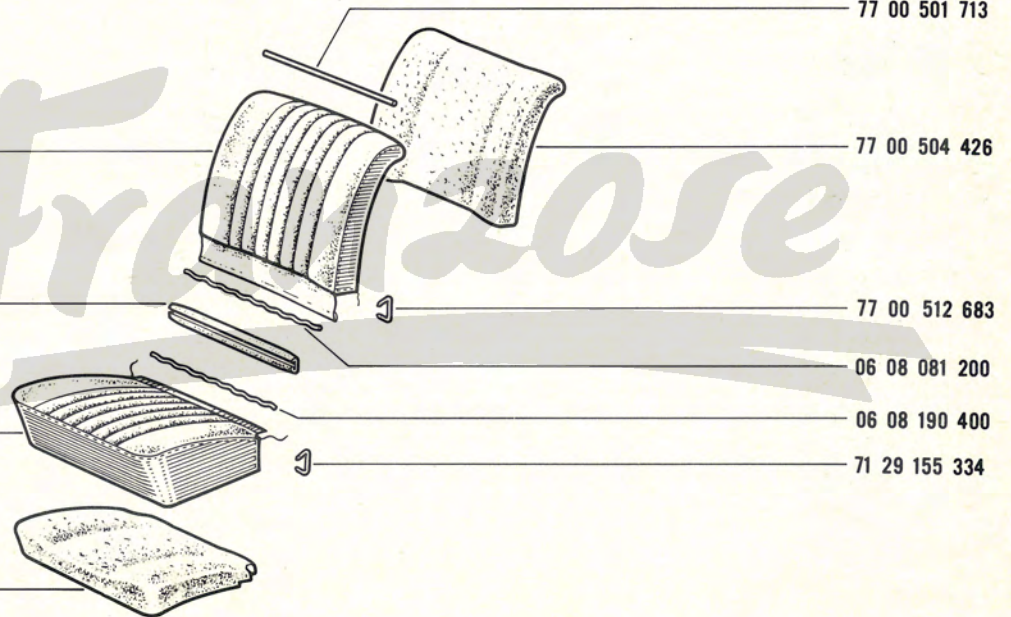

Der Freizeiter



84.36

B P.R. 880

R.1180 /120

84.36

B P.R. 880



- [5] [9] 77 01 450 932
- [5] [7] 77 01 450 961
- [14] [9] 77 01 450 930
- [10] [7] 77 01 450 960
- [20] [9] 77 01 450 931
- [21] [7] 77 01 450 962

06 08 253 800

06 08 081 100

- [5] [9] 77 01 450 889
- [5] [7] 77 01 450 901
- [14] [9] 77 01 450 887
- [10] [7] 77 01 450 900
- [20] [9] 77 01 450 888
- [21] [7] 77 01 450 902

08 57 661 500

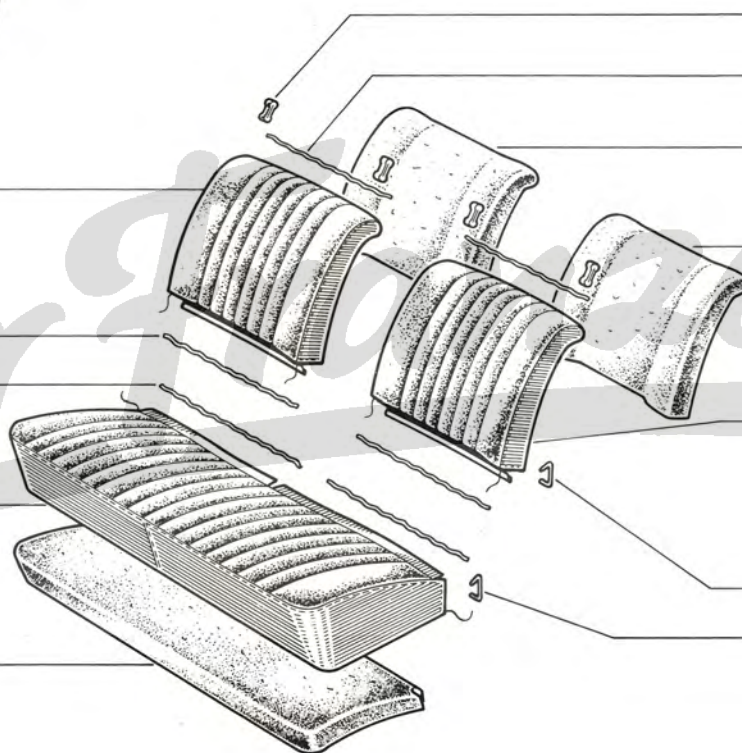

06 07 470 900

06 08 190 400

77 00 504 589

77 00 504 589

- 77 01 450 917 [9] [5]
- 77 01 450 946 [7] [5]
- 77 01 450 915 [9] [14]
- 77 01 450 945 [7] [10]
- 77 01 450 916 [9] [20]
- 77 01 450 947 [7] [21]

77 00 512 683

71 29 155 334



84.40

B P.R. 880

R.1180 /120

84.40

B P.R. 880

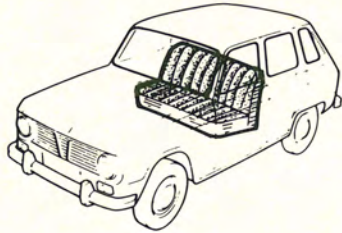
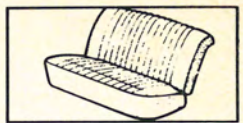

- [0] [E] 77 01 450 669
- [0] [Z] 77 01 450 700
- [0] [E] 77 01 450 670
- [0] [Z] 77 01 450 702
- [0] [E] 77 01 450 671
- [0] [Z] 77 01 450 701

06 08 356 200

06 08 081 100

- [0] [E] 77 01 450 654
- [0] [Z] 77 01 450 684
- [0] [E] 77 01 450 655
- [0] [Z] 77 01 450 686
- [0] [E] 77 01 450 656
- [0] [Z] 77 01 450 685

08 57 661 500

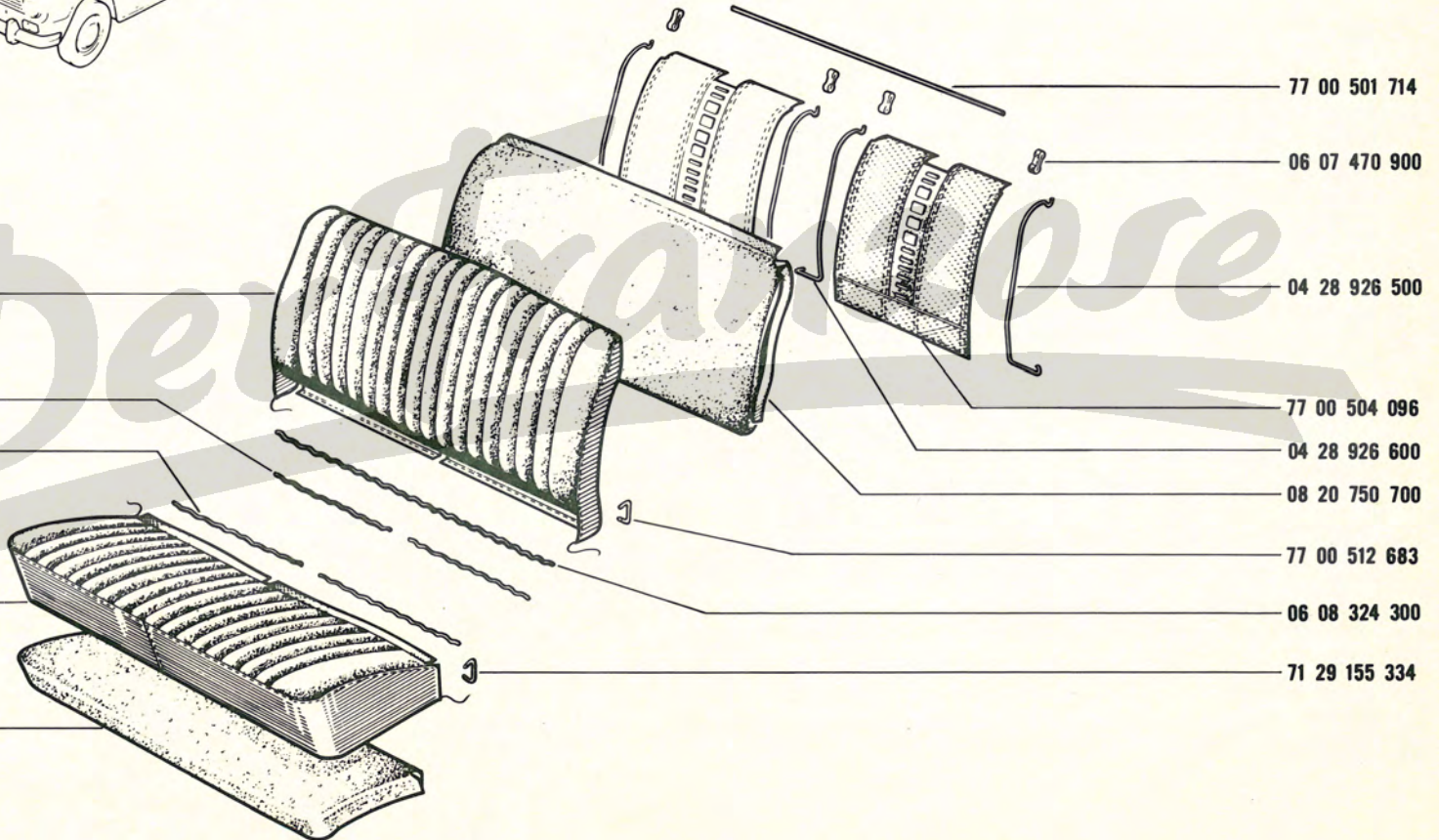

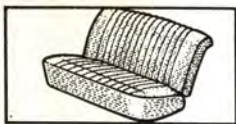

84.50

B P.R. 880

84.50

B P.R. 880

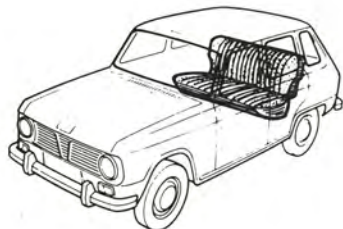
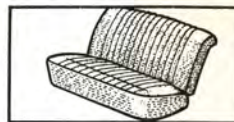

- [14] 8 77 01 450 790
- [14] 7 77 01 450 815
- [20] 8 77 01 450 791
- [20] 7 77 01 450 817
- [5] 8 77 01 450 792
- [5] 7 77 01 450 816

- [14] 8 77 01 450 775
- [14] 7 77 01 450 800
- [20] 8 77 01 450 776
- [20] 7 77 01 450 802
- [5] 8 77 01 450 777
- [5] 7 77 01 450 801

08 33 209 900

10 81 110 472

10 98 542 162

03 54 336 200

03 54 336 000

03 54 336 100

77 00 500 499

77 00 506 169

80 72 040 102

10 81 350 452

77 00 500 498

77 00 517 445

77 00 500 356

77 00 512 683

06 08 356 100

71 29 155 334

08 57 712 600

08 54 979 000

Derefer...

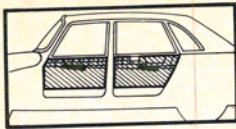

84.55

B P.R. 880

84.55

B P.R. 880



- [13] 77 00 504 898
- [21] 77 00 505 695
- [5] 77 00 505 697

77 00 501 426

08 54 983 600

- [13] 77 00 504 896
- [21] 77 00 505 699
- [5] 77 00 505 701

77 00 501 474

08 55 434 300

77 00 510 835

77 00 500 974

80 75 860 254

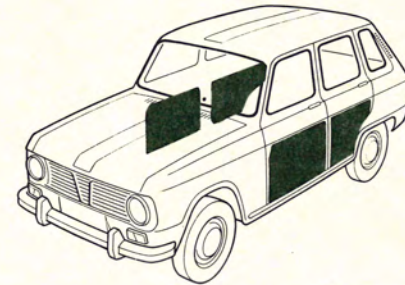
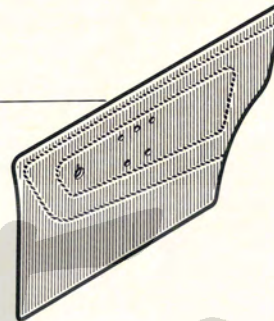

77 00 500 065

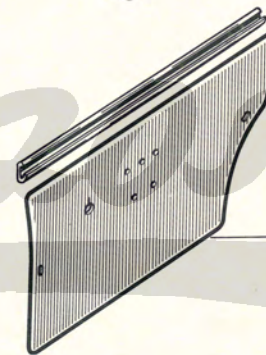

- [13] 77 00 504 897
- [21] 77 00 505 694
- [5] 77 00 505 696

77 00 500 063

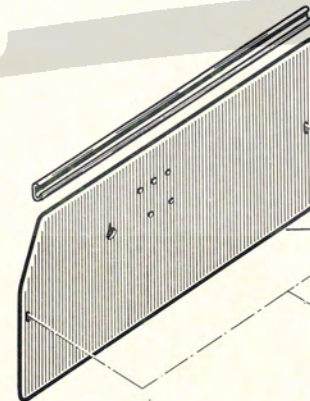

- [13] 77 00 504 895
- [21] 77 00 505 698
- [5] 77 00 505 700

08 55 823 100

08 55 823 000

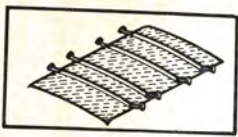

84.60

B P.R. 880

84.60

B P.R. 880

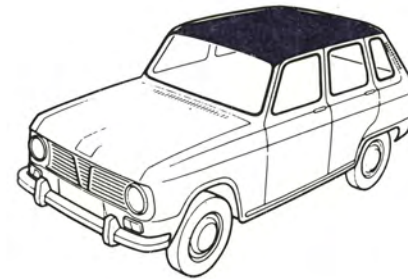
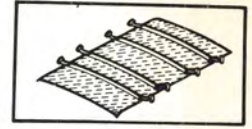

02 56 592 807

02 56 592 707

02 56 592 607

77 00 516 031

77 00 503 680

x23

02 56 592 907

77 00 500 381

Der
Mazore



85.32

A P.R. 880



85.32

A P.R. 880

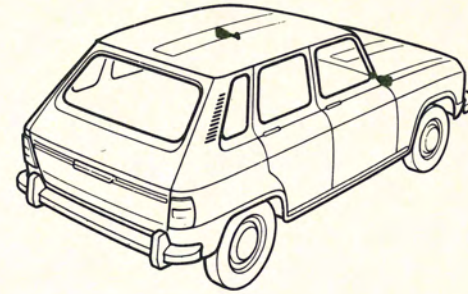

77 01 001 690

08 70 285 000

10 75 050 124

77 00 511 578

CIPA

08 55 145 200

08 70 284 900

08 70 284 700

08 70 284 800

08 70 285 300

77 01 001 689

77 00 516 403

GECO

(R 1180/245) 77 01 004 043

77 01 004 042

77 01 004 045

77 01 004 044

80 75 050 154

(R 1180/245)

GECO 77 00 516 406

77 01 004 046

Der Franzose

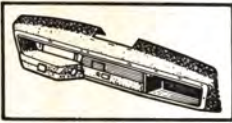

85.50

B P.R.880



85.50

B P.R.880

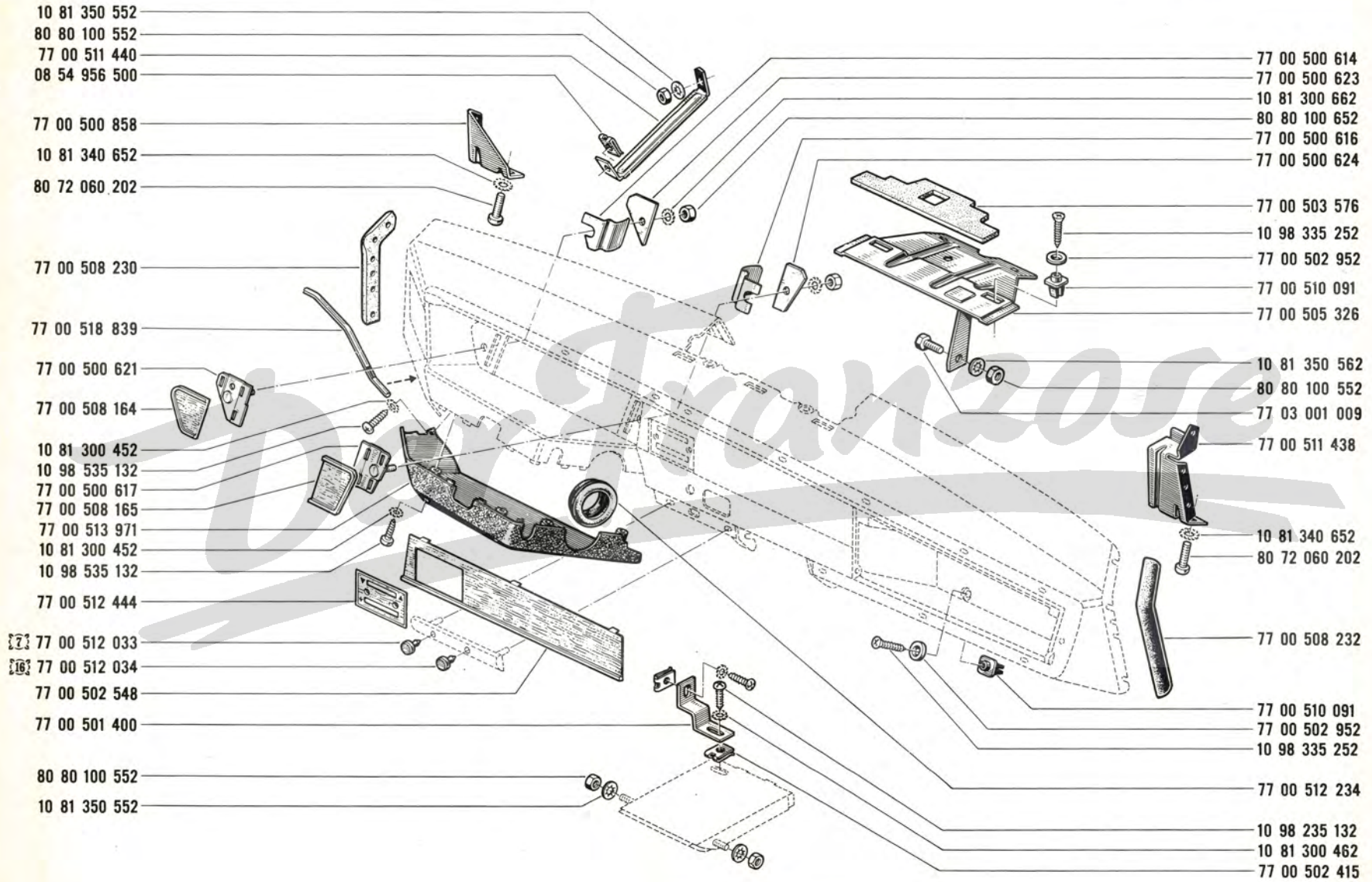
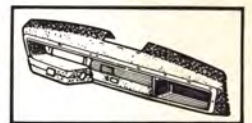

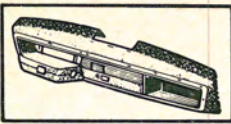

85.53

A P.R. 880



85.53

A P.R. 880

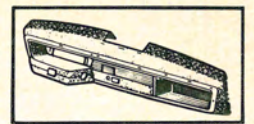

08 54 690 700

77 01 004 162

77 01 004 164

10 81 350 352

80 80 100 352

77 00 513 972

77 00 513 973

77 01 004 159

77 00 509 493

77 00 508 329

77 00 509 492

77 00 511 547

77 01 004 163

77 00 508 045

77 00 512 558

77 01 004 161

77 01 004 160

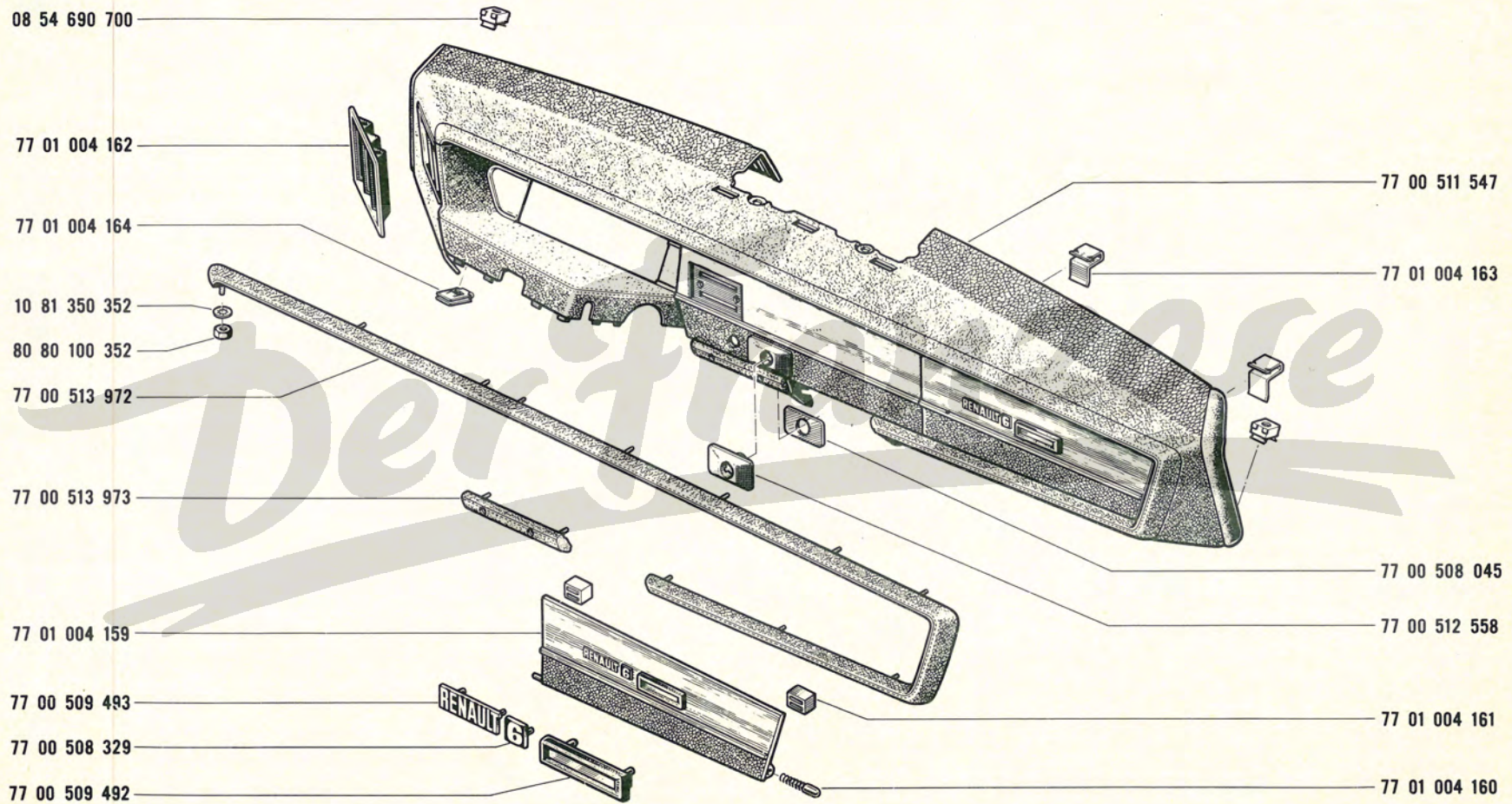

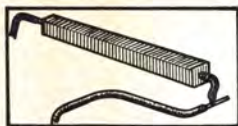

85.90

B P.R. 880

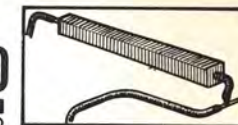

85.90

B P.R. 880

- (1) 77 00 508 400
- (2) 77 00 518 212

(1) 77 00 508 815

08 55 607 902

10 81 110 662

10 81 350 652

80 72 060 302

(2) 77 00 518 214

77 00 513 288

77 00 515 923

10 81 350 682

80 80 100 652

77 00 513 288

77 00 518 244 (b)

08 55 262 600

10 81 110 662

77 00 508 817

(1) 77 00 508 212

(2) 77 00 518 213

(b) 77 00 518 245

10 81 310 552

77 03 001 318

(a) 77 00 501 876

77 00 513 184

(3) 08 70 365 600

(4) 77 00 518 589

(3) 08 70 365 700

77 00 508 969

77 00 509 396

77 03 001 114

10 81 350 552

77 00 503 218

80 72 040 122

10 81 300 452

04 28 928 900

80 80 100 552

08 52 298 100

08 57 576 700

10 81 351 452

06 08 301 400

05 56 228 700

77 00 511 278

77 00 512 243 (a)

77 00 511 937 (b)

77 00 508 213 (1)

77 00 518 211 (2)

06 08 384 100

08 55 607 902

08 55 838 700 †

77 01 452 171

08 55 607 902

77 00 508 816

(a) R.1180 /240/241/242/245/246/550

(b) R.1180 /240/241/242/245/246/550

(1) SCOMAM

(2) SOFICA

(3) 08 55 838 700

(4) 77 01 452 171

Der Franzose